



EGLO

my light | my style



Außenleuchten
Outdoor lighting
Luminaires extérieurs

2015/16



Dear customers, business partners and trusted EGLO friends,

what could be more beautiful than spending time in the nature? We offer you the perfect lightning for your garden, your terrace and balcony. Our assortment of outdoor luminaires ranges from classic, to traditional, modern and extravagant luminaires. Explore and find your favorite for every matching atmosphere and enhance your personal sense of well-being.

Have fun flipping through our outdoor luminaire range!

Ludwig Obwieser
Gründer & Eigentümer
Owner & Founder
Propriétaire & fondateur

Geschätzte Kunden und Geschäftspartner, treue EGLO-Freunde,

Was gibt es Schöneres als die Zeit im Grünen zu verbringen? Wir bieten Ihnen dazu die perfekte Beleuchtung für Ihren Garten, Ihre Terrasse oder Ihren Balkon. Unser Sortiment an Außenleuchten reicht von klassischen, über traditionelle bis hin zu modernen und extravaganten Leuchten. Finden Sie Ihre Favoriten der für die passende Atmosphäre und Ihren persönlichen Wohlfühleffekt sorgt.

Viel Spaß beim Durchstöbern unseres Außenleuchtsortiments!

Chers clients et partenaires commerciaux, fidèles clients EGLO,

Qu'il y a t'il de plus agréable que de passer du temps à l'extérieur ? Nous vous proposons l'éclairage parfait pour le jardin, la terrasse ou le balcon. Notre palette d'éclairages extérieurs s'étend des modèles classiques et traditionnels aux éclairages modernes et extravagants. Vous trouverez vos éclairages préférés pour créer une atmosphère adaptée et pour votre bien-être personnel.

Amusez-vous à parcourir notre gamme d'éclairages extérieurs !



INHALT CONTENTS CONTENU



Products

	Modern Modern <i>Moderne</i>	004 - 063
	Classic Klassik <i>Classique</i>	064 - 107
	Spots, Recessed & Accessories Spots, Einbauleuchten & Zubehör <i>Spots, luminaires encastrés & accessoires</i>	108 - 121

Concepts

	Garden Living	122 - 129
---	----------------------	-----------

Appendix

	Overview sensor luminaires Übersicht Sensorleuchten <i>Aperçu de feux de capteur</i>	130 - 131
	Register & Legend Register & Legende <i>Registre & Légende</i>	132 - 136



Modern



Overview

									
PENALVA p. 8	PENALVA 1 p. 8	FONTACINA p. 10	BASALGO p. 10	BASALGO 1 p. 11	TRONO 2 p. 13	TRONO STICK p. 13	TRONO 1 p. 13	AGOLADA p. 14	ASCOLI p. 14
									
CABOS p. 14	MORINO p. 14	RIGA p. 16	RIGA p. 17	RIGA p. 17	RIGA 2 p. 17	RIGA-LED p. 18	RIGA 2 p. 19	HELSINKI-LED p. 19	HELSINKI p. 20
									
CADIZ 1 p. 21	ROFFIA p. 22	CALGARY p. 23	PANAMA 1 p. 24	MOUNA p. 26	ARIOLLA p. 27	NISIA 1 p. 27	NISIA p. 28	OHIO p. 28	SESIMBA p. 30
									
NAGO p. 31	LAVORIA p. 31	NOCELLA p. 31	MORINO p. 32	RUSTEGA p. 32	REDONDO p. 33	FONTELA p. 33	PARDELA p. 33	PIAS p. 34	CALGARY 1 p. 35
									
TABO-LED p. 35	PARDELA 1 p. 35	ZAMORANA p. 36	TABO p. 36	PREDAZZO p. 38	MORINO p. 38	KIBEA p. 38	NADELA p. 38	SONELLA p. 40	SONELLA 1 p. 40
									
INFESTO 1 p. 40	INFESTO p. 40	NADELA p. 42	MIRANO p. 42	VOLPINO p. 42	CORFINO p. 42	ACATE p. 42	ARCHA p. 42	MALGERA p. 44	BREGANZO p. 44



PARK 5
p. 44



PARK
p. 44



CITY LED
p. 46



CITY
p. 47



CITY
p. 47



CITY 1
p. 47



CERNO
p. 48



DARIL
p. 48



CERNO
p. 48



RALORA
p. 48



TRABADA
p. 50



TRABADA
p. 50



KONYA
p. 52



BENACO
p. 52



BEVERLY
p. 52



BENACO
p. 52



RAVARINO
p. 52



FASTRO
p. 54



FASTRO 1
p. 54



SOJO
p. 54



BOSARO
p. 54



ONTANEDA
p. 56



CITY 2
p. 56



VENTO 1
p. 56



VENTO 1
p. 56



ISOBA
p. 58



ONJA
p. 58



SIONES
p. 60



SIONES
p. 60



ANOLA
p. 60



ANOLA
p. 61



MILTON
p. 62



SEVILLA
p. 62



CITY
p. 62



LEPUS
p. 62

LED

94813 PENALVA

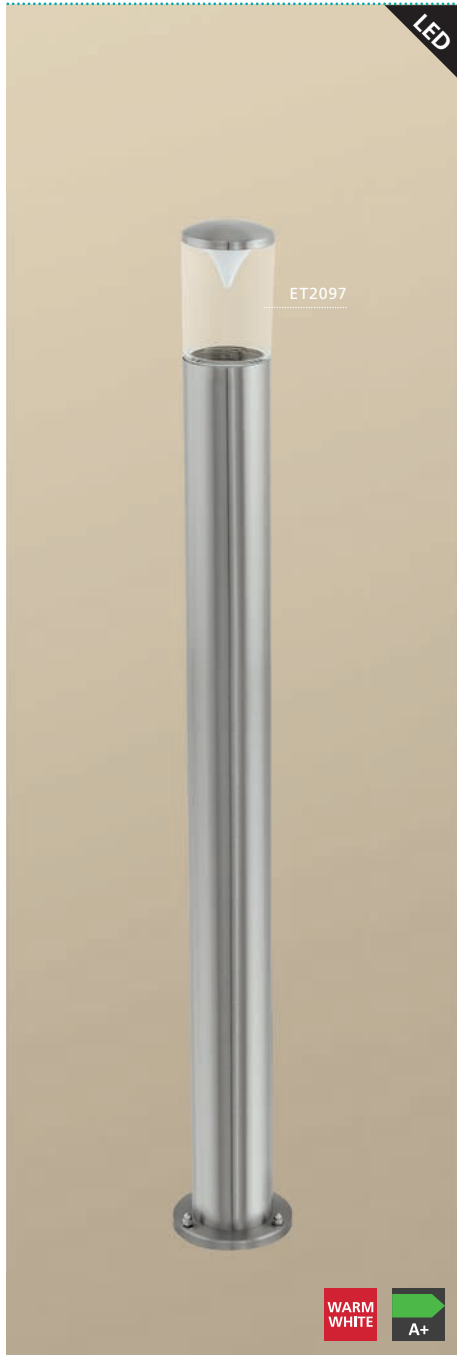

floor luminaire; stainless steel, stainless steel / plastic, clear, white
Stehleuchte; Edelstahl, edelstahl / Kunststoff, klar, weiss
lampadaire; acier inoxydable, acier inoxydable / plastique, clair, blanc

L 75, H 995, Base: Ø 115

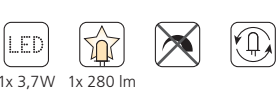

ET2097



94811 PENALVA



wall luminaire; stainless steel, stainless steel / plastic, clear, white
Wandleuchte; Edelstahl, edelstahl / Kunststoff, klar, weiss
applique; acier inoxydable, acier inoxydable / plastique, clair, blanc

L 75, H 225, A 110

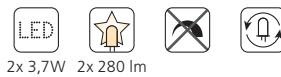

ET2097

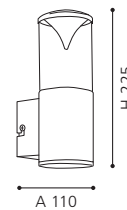

94817 PENALVA 1



wall luminaire; galvanized steel, black / plastic, gold
Wandleuchte; Stahl verzinkt, schwarz / Kunststoff, klar, gold
applique; acier galvanisé, noir / plastique, gold

L 75, H 225, A 110

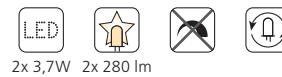

ET2098

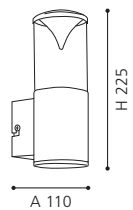

94812 PENALVA



wall luminaire; stainless steel, stainless steel / plastic, clear, white
Wandleuchte; Edelstahl, edelstahl / Kunststoff, klar, weiss
applique; acier inoxydable, acier inoxydable / plastique, clair, blanc

L 75, H 335, A 110

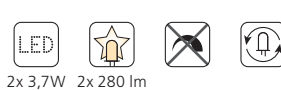

ET2097

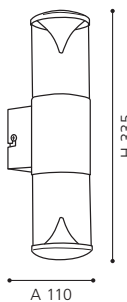

94818 PENALVA 1

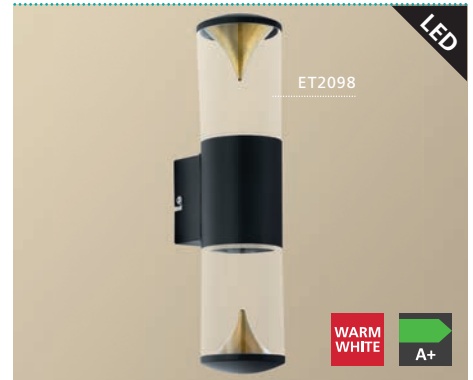

wall luminaire; galvanized steel, black / plastic, gold
Wandleuchte; Stahl verzinkt, schwarz / Kunststoff, klar, gold
applique; acier galvanisé, noir / plastique, gold

L 75, H 335, A 110



ET2098

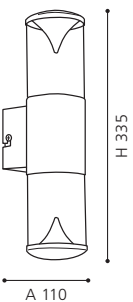

LED

94819 PENALVA 1



floor luminaire; galvanized steel, black / plastic, gold
 Stehleuchte; Stahl verzinkt, schwarz / Kunststoff, klar, gold
 lampadaire; acier galvanisé, noir / plastique, gold

L 75, H 995, Base: Ø 115



ET2098



PENALVA & PENALVA 1



With direkt and/or indirect light this luminaire create a spectacular effect.

Diese Leuchten schaffen durch direktes und/oder indirektes Licht einen tollen Effekt.

Ce luminaire créé un effets lumineux special pour une illumination direct et/ou indirect.

LED

94132 FONTACINA



floor luminaire; stainless steel, stainless steel / structured glass, clear
Stehleuchte; Edelstahl, edelstahl / Glas mit Struktur, klar
lampadaire; acier inoxydable, acier inoxydable / verre structuré, clair

H 965, Ø 75

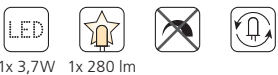

GL3199



94131 FONTACINA



wall luminaire; stainless steel, stainless steel / structured glass, clear
Wandleuchte; Edelstahl, edelstahl / Glas mit Struktur, klar
applique; acier inoxydable, acier inoxydable / verre structuré, clair

L 75, H 230, A 110

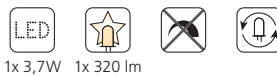

GL3199

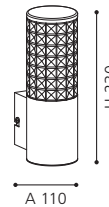

93269 BASALGO



wall luminaire; stainless steel, stainless steel / plastic, clear
Wandleuchte; Edelstahl, edelstahl / Kunststoff, klar
applique; acier inoxydable, acier inoxydable / plastique, clair

L 100, H 210, A 150

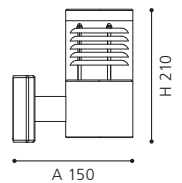

94277 BASALGO 1



wall luminaire; stainless steel, stainless steel / plastic, clear, white
Wandleuchte; Edelstahl, edelstahl / Kunststoff, klar, weiss
applique; acier inoxydable, acier inoxydable / plastique, clair, blanc

L 105, H 180, A 210

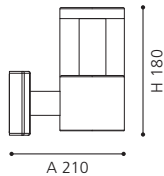
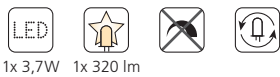

ET1836, ET1837

94278 BASALGO 1



floor luminaire; stainless steel, stainless steel / plastic, clear, white
Stehleuchte; Edelstahl, edelstahl / Kunststoff, klar, weiss
lampadaire; acier inoxydable, acier inoxydable / plastique, clair, blanc

H 450, Ø 105

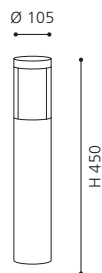
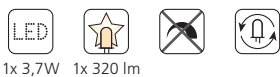

ET1836, ET1837

94279 BASALGO 1



floor luminaire; stainless steel, stainless steel / plastic, clear, white
Stehleuchte; Edelstahl, edelstahl / Kunststoff, klar, weiss
lampadaire; acier inoxydable, acier inoxydable / plastique, clair, blanc

H 1050, Ø 105

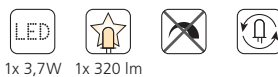

ET1836, ET1837

94281 BASALGO 1

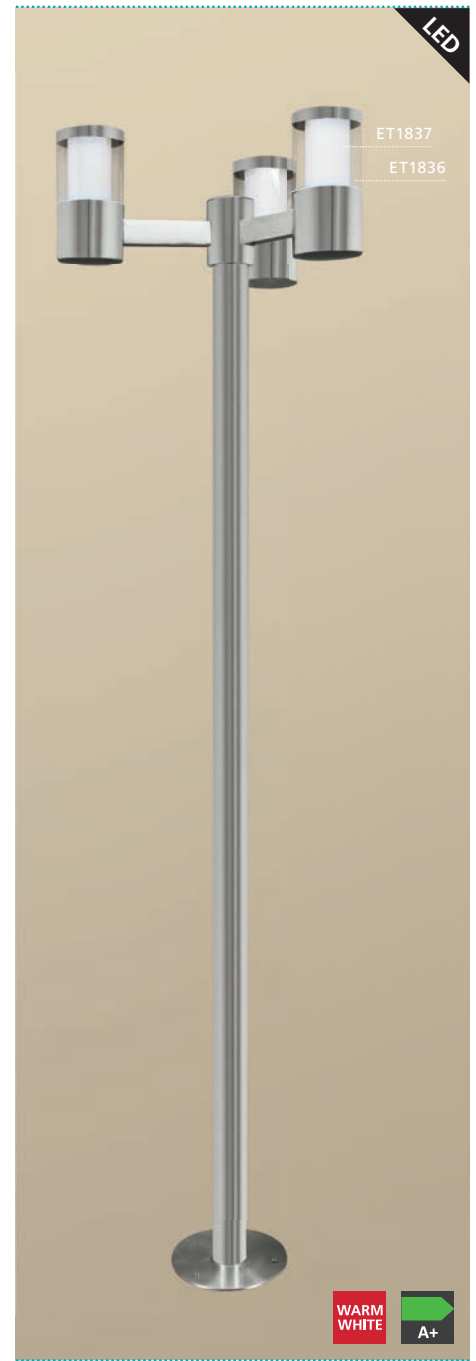

floor luminaire; stainless steel, stainless steel / plastic, clear, white
Stehleuchte; Edelstahl, edelstahl / Kunststoff, klar, weiss
lampadaire; acier inoxydable, acier inoxydable / plastique, clair, blanc

H 1900, Ø 490

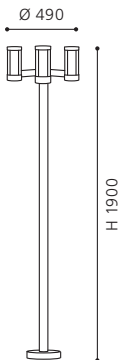
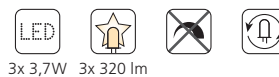

ET1836, ET1837

LED



TRONO 1, TRONO 2, TRONO STICK



These luminaires come with lighting that is directed upwards as well as downwards.

Diese Leuchten sind sowohl mit nach oben als auch mit nach unten gerichteten Leuchten ausgestattet.

Ces luminaires brillent non seulement vers le bas, mais aussi vers le haut.

94125 TRONO 2



wall luminaire; stainless steel, stainless steel / glass, crystal, clear
Wandleuchte; Edelstahl, edelstahl / Glas, Kristall, klar
applique; acier inoxydable, acier inoxydable / verre, cristal, clair

L 105, H 350, A 115

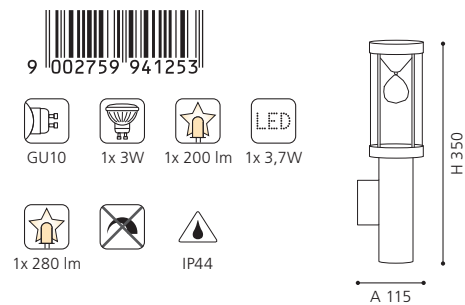

GL1618

94127 TRONO STICK

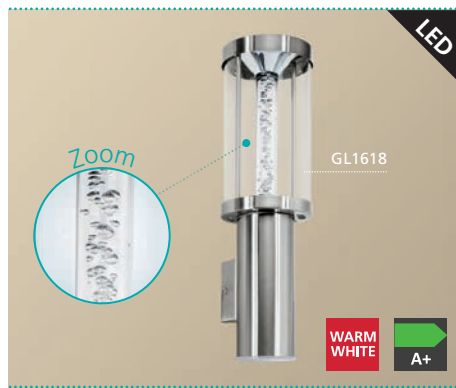

wall luminaire; stainless steel, stainless steel / glass, plastic, clear
Wandleuchte; Edelstahl, edelstahl / Glas, Kunststoff, klar
applique; acier inoxydable, acier inoxydable / verre, plastique, clair

L 105, H 350, A 115

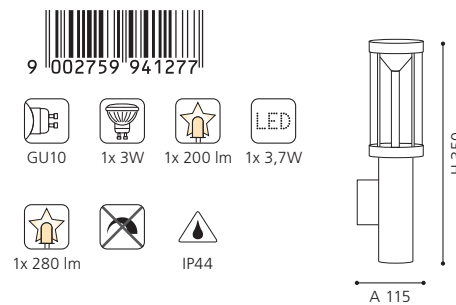

GL1618

94208 TRONO 1



wall luminaire; stainless steel, stainless steel / glass, clear
Wandleuchte; Edelstahl, edelstahl / Glas, klar
applique; acier inoxydable, acier inoxydable / verre, clair

L 105, H 350, A 115

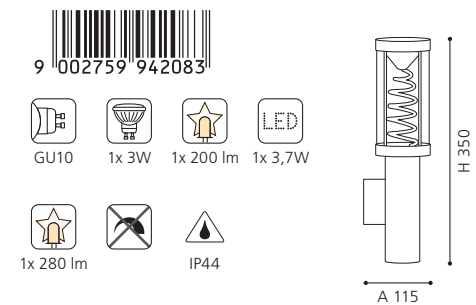

GL1618

94126 TRONO 2



wall luminaire; stainless steel, stainless steel / glass, crystal, clear
Wandleuchte; Edelstahl, edelstahl / Glas, Kristall, klar
applique; acier inoxydable, acier inoxydable / verre, cristal, clair

L 105, H 410, A 175

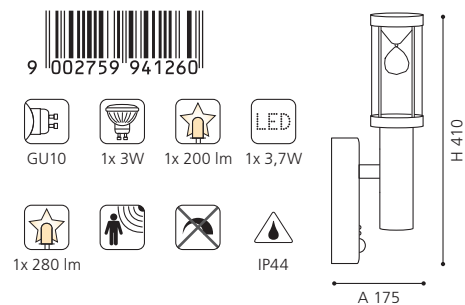

GL1618

94128 TRONO STICK



wall luminaire; stainless steel, stainless steel / glass, plastic, clear
Wandleuchte; Edelstahl, edelstahl / Glas, Kunststoff, klar
applique; acier inoxydable, acier inoxydable / verre, plastique, clair

L 105, H 410, A 175

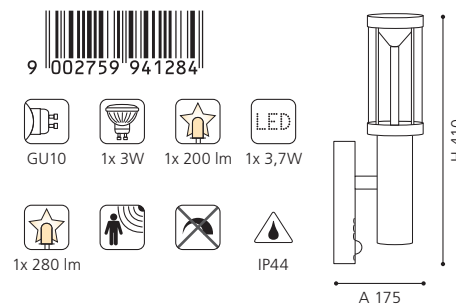

GL1618

94209 TRONO 1



wall luminaire; stainless steel, stainless steel / glass, clear
Wandleuchte; Edelstahl, edelstahl / Glas, klar
applique; acier inoxydable, acier inoxydable / verre, clair

L 105, H 410, A 175

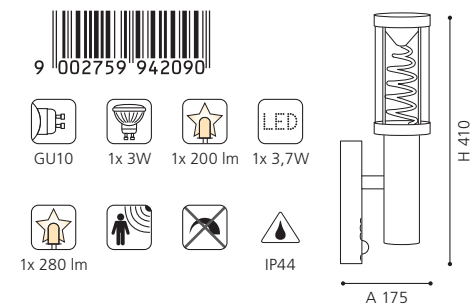

GL1618

LED

94803 AGOLADA

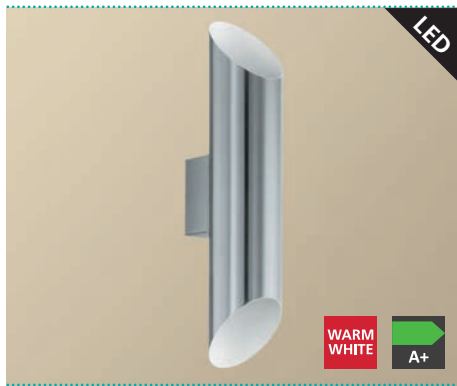

wall luminaire; stainless steel, stainless-steel, white
Wandleuchte; Edelstahl, edelstahl, weiss
applique; acier inoxydable, stainless-steel, white

94802 AGOLADA



wall luminaire; galvanized steel, white
Wandleuchte; Stahl verzinkt, weiss
applique; acier galvanisé, blanc

94804 AGOLADA



wall luminaire; galvanized steel, black, copper
Wandleuchte; Stahl verzinkt, schwarz, kupfer
applique; acier galvanisé, noir, cuivre

L 75, H 360, A 110

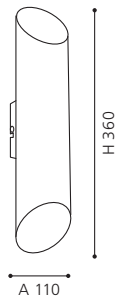

L 75, H 360, A 110

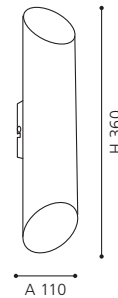

L 75, H 360, A 110

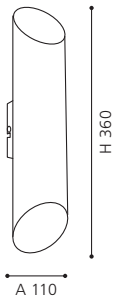
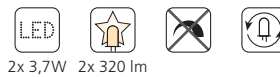

90121 ASCOLI



wall luminaire; stainless steel, stainless steel / glass, clear
Wandleuchte; Edelstahl, edelstahl / Glas, klar
applique; acier inoxydable, acier inoxydable / verre, clair

93271 CABOS



wall luminaire; stainless steel, stainless steel / glass, satin
Wandleuchte; Edelstahl, edelstahl / Glas, satiniert
applique; acier inoxydable, acier inoxydable / verre, satiné

93488 MORINO



wall luminaire; cast aluminium, silver / satinated glass, white
Wandleuchte; Aluguss, silber / Glas satiniert, weiss
applique; aluminium moulé, argent / verre satiné, blanc

L 125, H 325, A 160

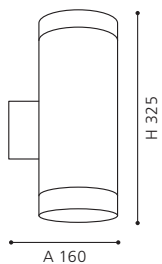
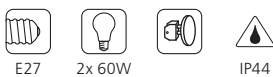

L 75, H 210, A 90

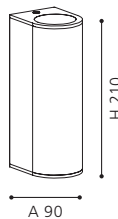
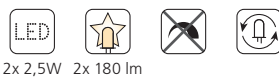

GL3025

L 160, H 235, A 80

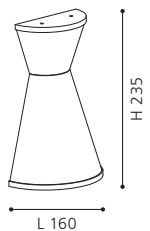
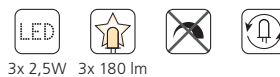

GL3028, GL3029

LED



93488



This luminaire can be mounted in two positions.

Diese Leuchte kann in zwei Varianten montiert werden.

Ce luminaire peut être monté de deux manières.

LED

94105 RIGA



wall luminaire; galvanized steel, antique brown
Wandleuchte; Stahl verzinkt, antik-braun
applique; acier galvanisé, marron antique

94103 RIGA



wall luminaire; galvanized steel, anthracite
Wandleuchte; Stahl verzinkt, anthrazit
applique; acier galvanisé, anthracite

94101 RIGA



wall luminaire; galvanized steel, white
Wandleuchte; Stahl verzinkt, weiss
applique; acier galvanisé, blanc

L 65, H 200, A 95

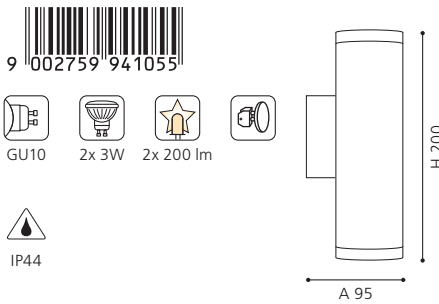

L 65, H 200, A 95

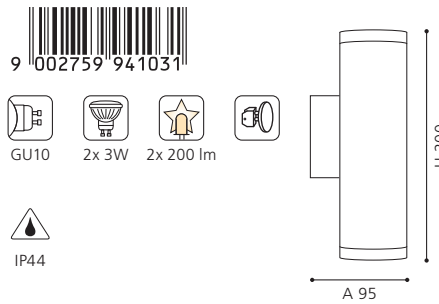

L 65, H 200, A 95

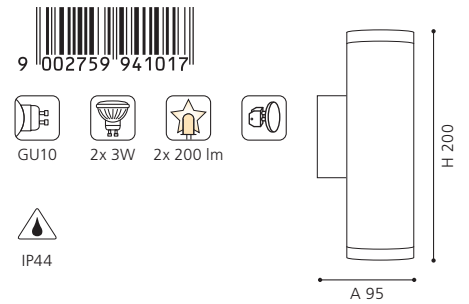

94104 RIGA



wall luminaire; galvanized steel, antique brown
Wandleuchte; Stahl verzinkt, antik-braun
applique; acier galvanisé, marron antique

94102 RIGA



wall luminaire; galvanized steel, anthracite
Wandleuchte; Stahl verzinkt, anthrazit
applique; acier galvanisé, anthracite

94099 RIGA



wall luminaire; galvanized steel, white
Wandleuchte; Stahl verzinkt, weiss
applique; acier galvanisé, blanc

L 65, H 150, A 95

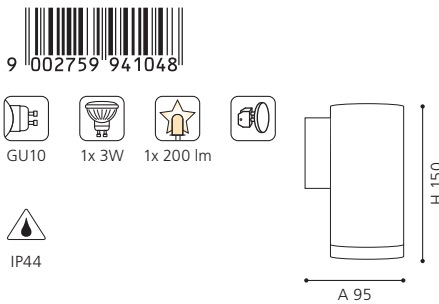

L 65, H 150, A 95

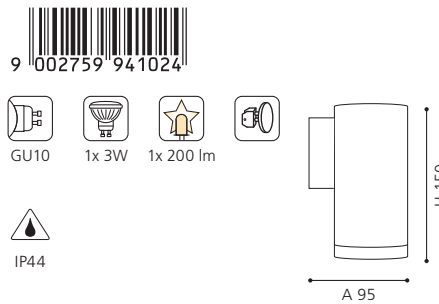

L 65, H 150, A 95

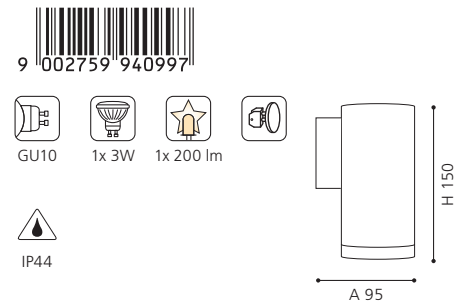

94107 RIGA

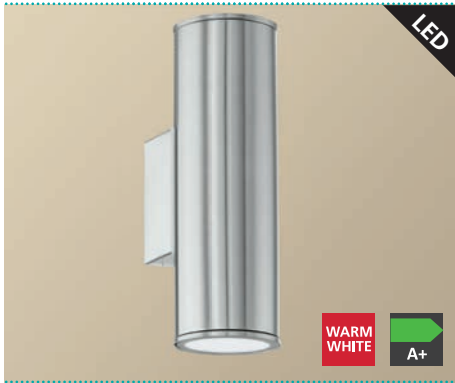

wall luminaire; stainless steel, stainless steel
Wandleuchte; Edelstahl, edelstahl
applique; acier inoxydable, acier inoxydable

L 65, H 200, A 95

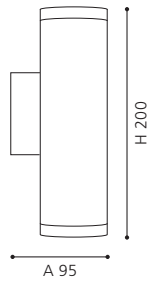

84002 RIGA

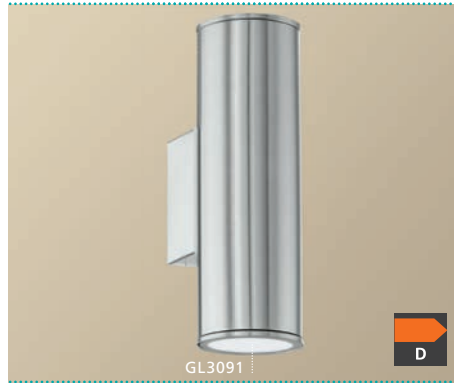

wall luminaire; stainless steel, stainless steel
Wandleuchte; Edelstahl, edelstahl
applique; acier inoxydable, acier inoxydable

L 65, H 200, A 95

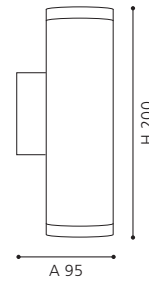

GL3091

94098 RIGA 2



wall luminaire; stainless steel, stainless steel
Wandleuchte; Edelstahl, edelstahl
applique; acier inoxydable, acier inoxydable

L 100, H 340, A 95

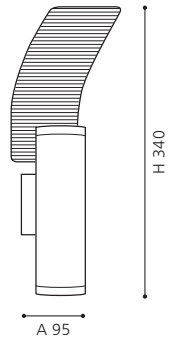

94106 RIGA

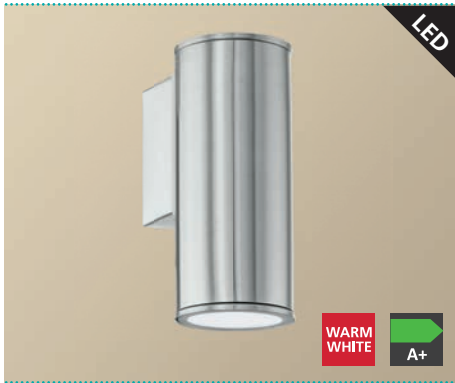

wall luminaire; stainless steel, stainless steel
Wandleuchte; Edelstahl, edelstahl
applique; acier inoxydable, acier inoxydable

L 65, H 150, A 95

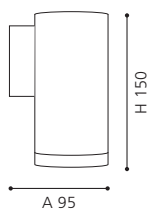

83998 RIGA



wall luminaire; stainless steel, stainless steel
Wandleuchte; Edelstahl, edelstahl
applique; acier inoxydable, acier inoxydable

L 65, H 150, A 95

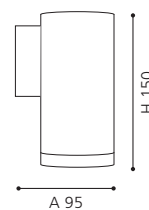

GL3091



LED

92735 RIGA-LED



wall luminaire; stainless steel, stainless steel / plastic, satined
Wandleuchte; Edelstahl, edelstahl / Kunststoff, satiniert
applique; acier inoxydable, acier inoxydable / plastique, satiné

L 65, H 160, A 95



IP44

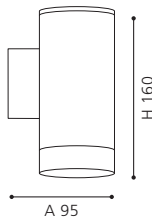

ET1408

92736 RIGA-LED



wall luminaire; stainless steel, stainless steel / plastic, satined
Wandleuchte; Edelstahl, edelstahl / Kunststoff, satiniert
applique; acier inoxydable, acier inoxydable / plastique, satiné

L 65, H 205, A 95

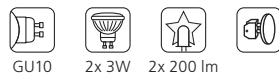

IP44

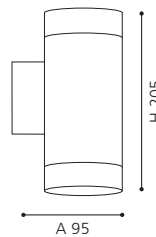

ET1408

92738 RIGA-LED

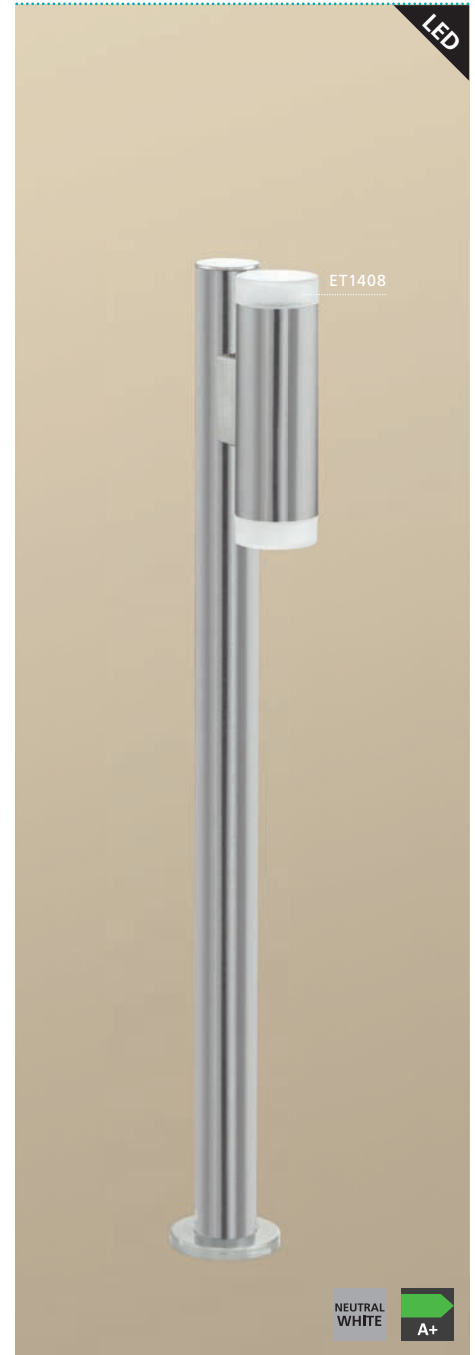

floor luminaire; stainless steel, stainless steel / plastic, satined
Stehleuchte; Edelstahl, edelstahl / Kunststoff, satiniert
lampadaire; acier inoxydable, acier inoxydable / plastique, satiné

L 130, B 65, H 805, Base: Ø 90



GU10

2x 3W

2x 200 lm

IP44

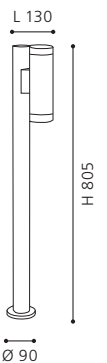

ET1408

92737 RIGA-LED



floor luminaire; stainless steel, stainless steel / plastic, satined
Stehleuchte; Edelstahl, edelstahl / Kunststoff, satiniert
lampadaire; acier inoxydable, acier inoxydable / plastique, satiné

L 130, B 65, H 355, Base: Ø 90



GU10

1x 3W

1x 200 lm

IP44

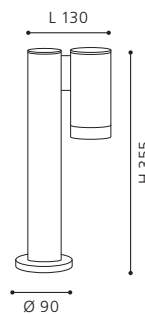

ET1408



94108 RIGA 2



floor luminaire; stainless steel, stainless steel
 Stehleuchte; Edelstahl, edelstahl
 lampadaire; acier inoxydable, acier inoxydable

B 130, H 800, Base: Ø 90



9 002759 941086



GU10 1x 3W 1x 200 lm IP44

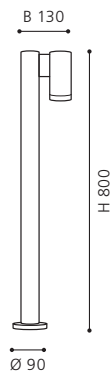

93331 HELSINKI-LED



floor luminaire; stainless steel, stainless steel / plastic, white
 Stehleuchte; Edelstahl, edelstahl / Kunststoff, weiss
 lampadaire; acier inoxydable, acier inoxydable / plastique, blanc

H 1100, Ø 75, Base: Ø 115



9 002759 933319



E27 1x 4W 1x 320 lm IP44



ET0968

93328 HELSINKI-LED



wall luminaire; stainless steel, stainless steel / plastic, white
 Wandleuchte; Edelstahl, edelstahl / Kunststoff, weiss
 applique; acier inoxydable, acier inoxydable / plastique, blanc

H 390, Ø 75, A 165



9 002759 933289



E27 1x 4W 1x 320 lm



IP44

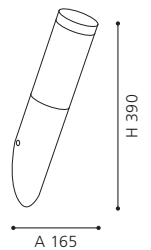

ET0968

93329 HELSINKI-LED



floor luminaire; stainless steel, stainless steel / plastic, white
 Stehleuchte; Edelstahl, edelstahl / Kunststoff, weiss
 lampadaire; acier inoxydable, acier inoxydable / plastique, blanc

H 450, Ø 75, Base: Ø 115



9 002759 933296



E27 1x 4W 1x 320 lm IP44

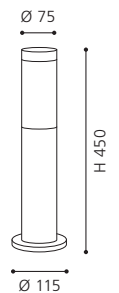

ET0968

83281 HELSINKI



floor luminaire; stainless steel, stainless steel / plastic, white
 Stehleuchte; Edelstahl, edelstahl / Kunststoff, weiss
 lampadaire; acier inoxydable, acier inoxydable / plastique, blanc

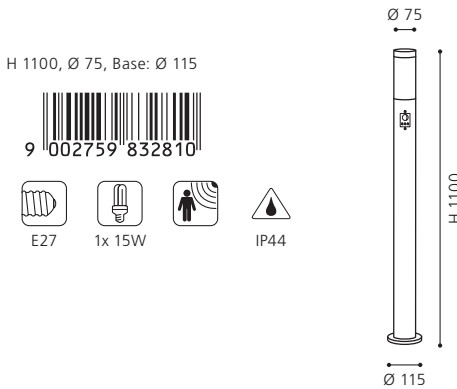

ET0968

81752 HELSINKI



floor luminaire; stainless steel, stainless steel / plastic, white
 Stehleuchte; Edelstahl, edelstahl / Kunststoff, weiss
 lampadaire; acier inoxydable, acier inoxydable / plastique, blanc

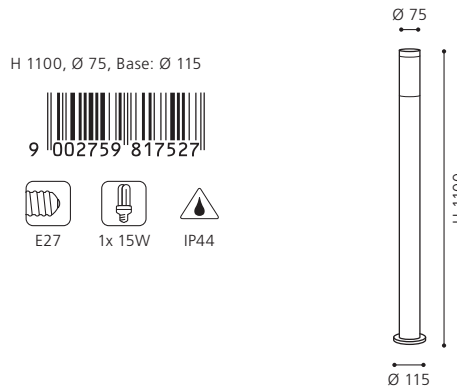

ET0968

83279 HELSINKI



floor luminaire; stainless steel, stainless steel / plastic, white
 Stehleuchte; Edelstahl, edelstahl / Kunststoff, weiss
 lampadaire; acier inoxydable, acier inoxydable / plastique, blanc

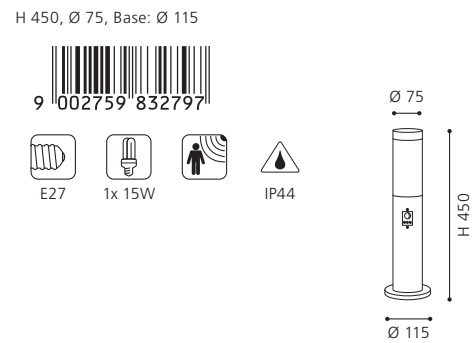

ET0968

81751 HELSINKI



floor luminaire; stainless steel, stainless steel / plastic, white
 Stehleuchte; Edelstahl, edelstahl / Kunststoff, weiss
 lampadaire; acier inoxydable, acier inoxydable / plastique, blanc

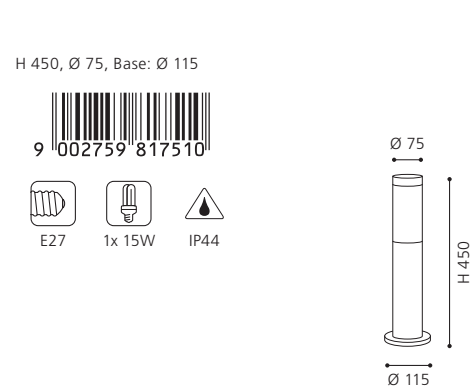

ET0968

83278 HELSINKI



wall luminaire; stainless steel, stainless steel / plastic, white
 Wandleuchte; Edelstahl, edelstahl / Kunststoff, weiss
 applique; acier inoxydable, acier inoxydable / plastique, blanc

81753 HELSINKI

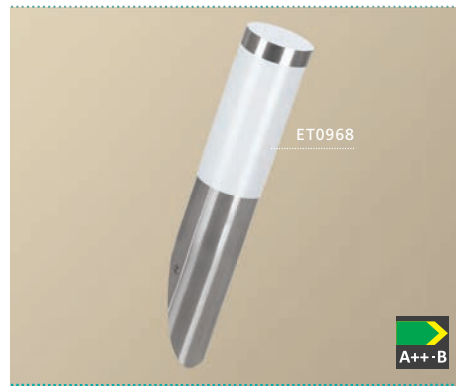

wall luminaire; stainless steel, stainless steel / plastic, white
 Wandleuchte; Edelstahl, edelstahl / Kunststoff, weiss
 applique; acier inoxydable, acier inoxydable / plastique, blanc

92335 CADIZ 1

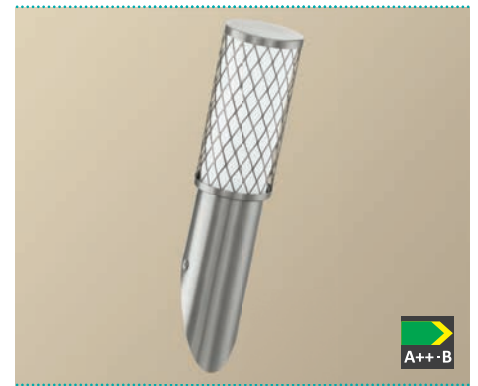

wall luminaire; stainless steel, stainless steel / plastic, white
 Wandleuchte; Edelstahl, edelstahl / Kunststoff, weiss
 applique; acier inoxydable, acier inoxydable / plastique, blanc

H 425, Ø 75, A 165

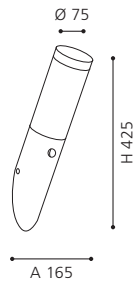

ET0968

H 390, Ø 75, A 165

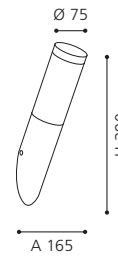
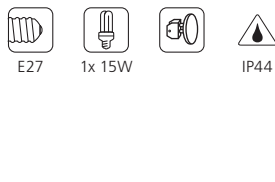

ET0968

H 390, Ø 90, A 165

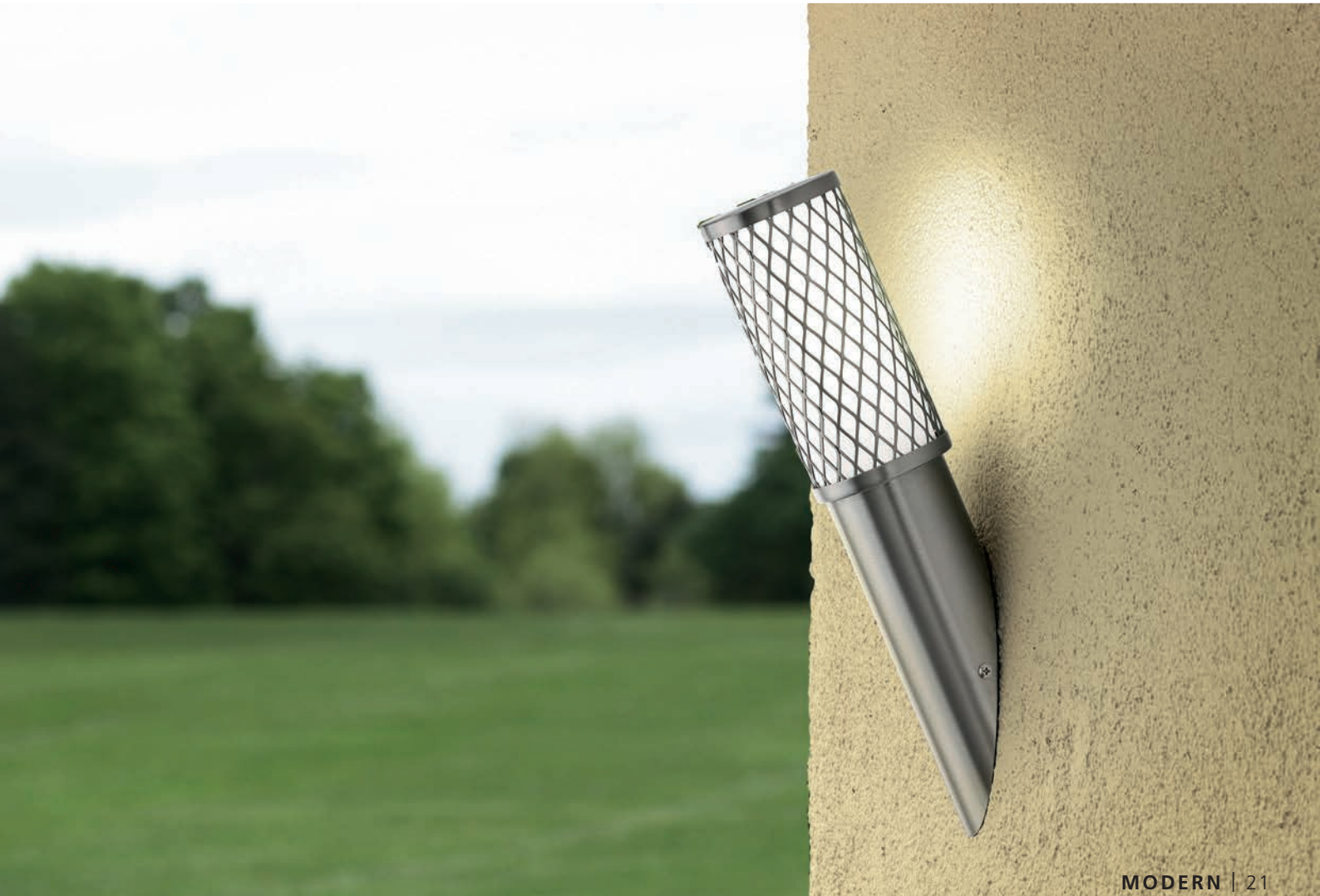
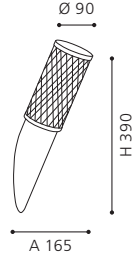
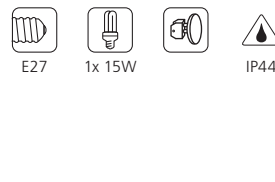

LED

94088 ROFFIA

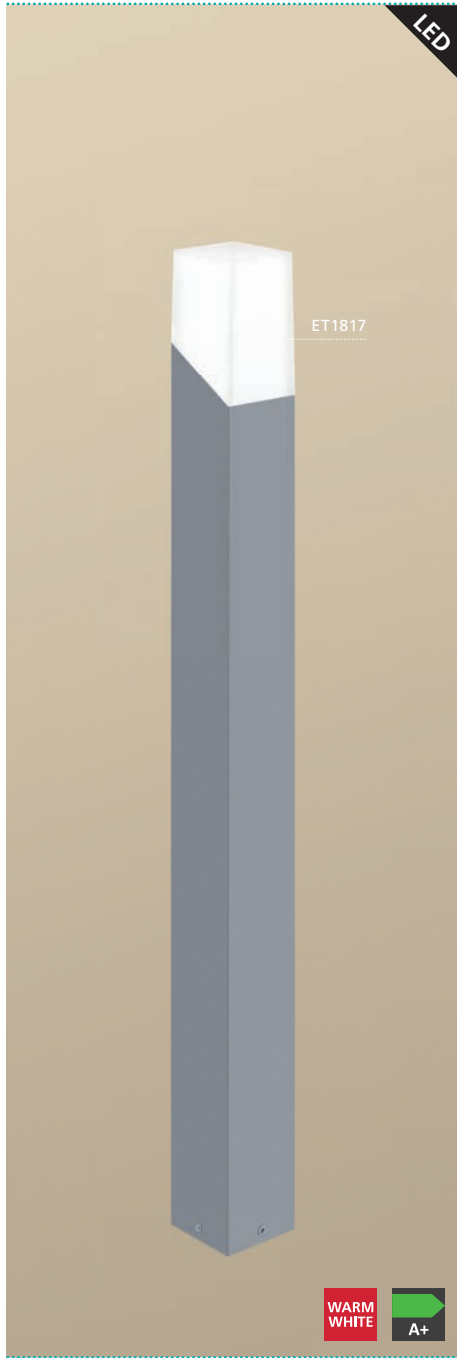

floor luminaire; aluminium, silver / plastic, white
 Stehleuchte; Alu, silber / Kunststoff, weiss
 lampadaire; aluminium, argent / plastique, blanc

WARM WHITE A+

94087 ROFFIA



wall luminaire; aluminium, silver / plastic, white
 Wandleuchte; Alu, silber / Kunststoff, weiss
 applique; aluminium, argent / plastique, blanc

WARM WHITE A+

94118 ROFFIA



wall luminaire; aluminium, silver / plastic, white
 Wandleuchte; Alu, silber / Kunststoff, weiss
 applique; aluminium, argent / plastique, blanc

WARM WHITE A+

L 90, H 210, A 120



9 002759 940874

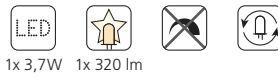

1x 3,7W 1x 320 lm



IP44

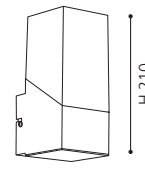

A 120

ET1817

L 90, H 340, A 120



9 002759 941185



2x 3,7W 2x 320 lm



IP44

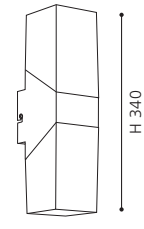

A 120

ET1810

L 90, B 90, H 1000



9 002759 940881

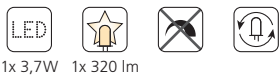

1x 3,7W 1x 320 lm



IP44



B 90

ET1817



86389 CALGARY

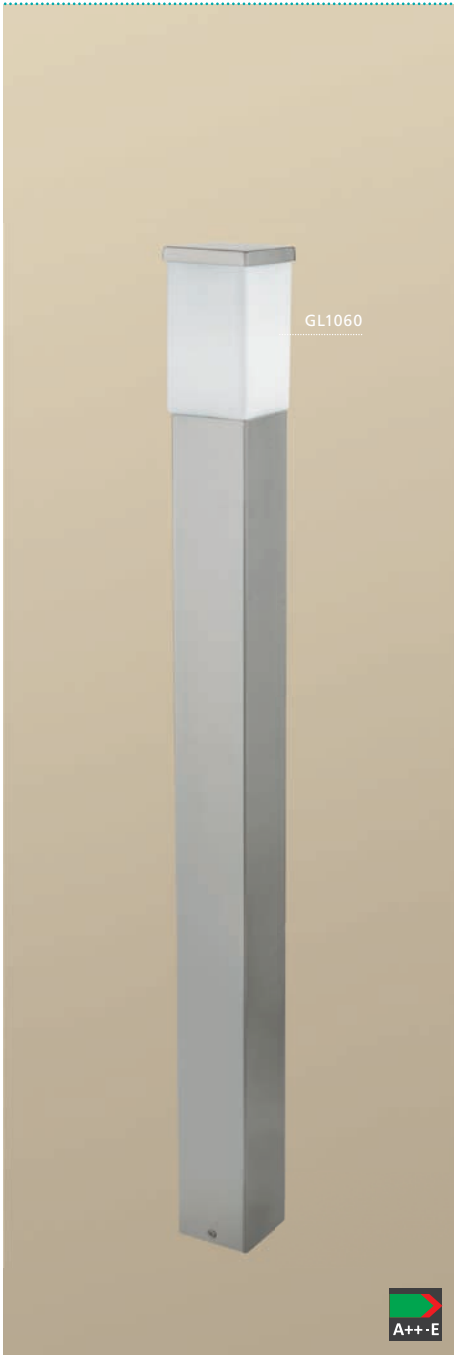

floor luminaire; stainless steel, stainless steel / opal glass, white
 Stehleuchte; Edelstahl, edelstahl / Glas opal-matt, weiss
 lampadaire; acier inoxydable, acier inoxydable / verre opale, blanc

L 100, B 100, H 1100, Base: B 90, T 90

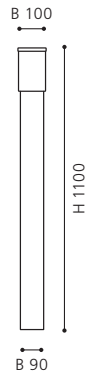

GL1060

86388 CALGARY



floor luminaire; stainless steel, stainless steel / opal glass, white
 Stehleuchte; Edelstahl, edelstahl / Glas opal-matt, weiss
 lampadaire; acier inoxydable, acier inoxydable / verre opale, blanc

L 100, B 100, H 435, Base: B 90, T 90

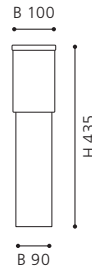

GL1060

86387 CALGARY



wall luminaire; stainless steel, stainless steel / opal glass, white
 Wandleuchte; Edelstahl, edelstahl / Glas opal-matt, weiss
 applique; acier inoxydable, acier inoxydable / verre opale, blanc

L 100, H 270, A 120, Base: B 90, T 90

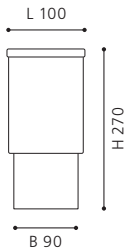

GL1060



LED

93523 PANAMA 1

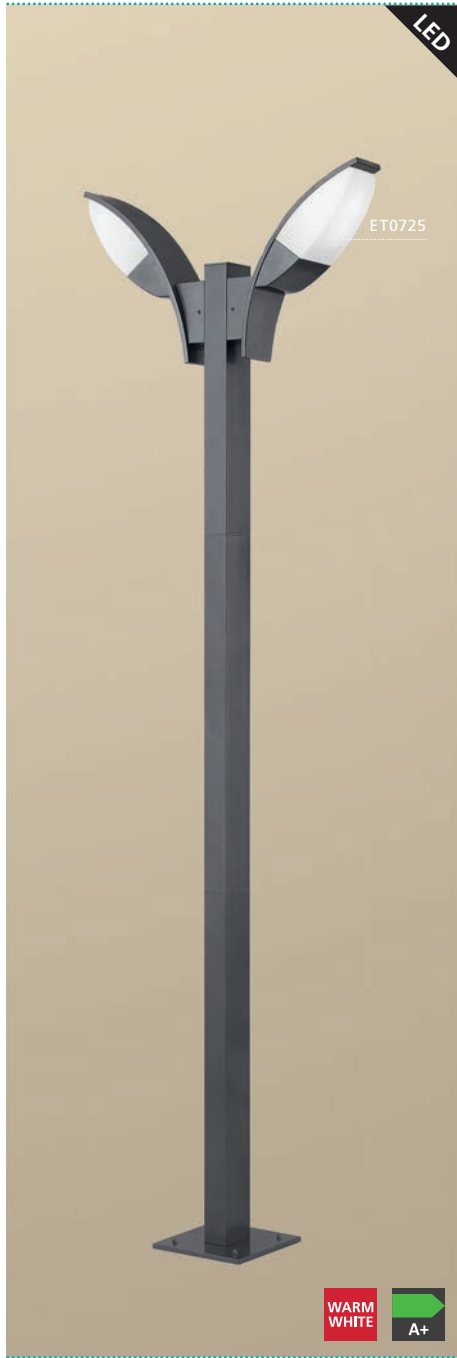

floor luminaire; cast aluminium, anthracite / plastic, white
Stehleuchte; Aluguss, anthrazit / Kunststoff, weiss
lampadaire; aluminium moulé, anthracite / plastique, blanc

93522 PANAMA 1



floor luminaire; cast aluminium, anthracite / plastic, white
Stehleuchte; Aluguss, anthrazit / Kunststoff, weiss
lampadaire; aluminium moulé, anthracite / plastique, blanc

L 110, H 1050, Base: B 205, T 75

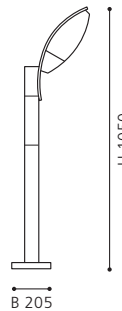

ET0725

93519 PANAMA 1



wall luminaire; cast aluminium, anthracite / plastic, white
Wandleuchte; Aluguss, anthrazit / Kunststoff, weiss
applique; aluminium moulé, anthracite / plastique, blanc

L 110, H 345, A 285

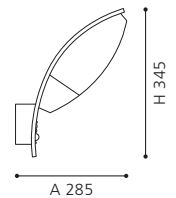
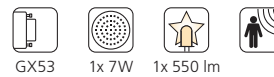

ET0725

93521 PANAMA 1



pedestal luminaire; cast aluminium, anthracite / plastic, white
Sockelleuchte; Aluguss, anthrazit / Kunststoff, weiss
borne; aluminium moulé, anthracite / plastique, blanc

L 110, H 500, Base: B 205, T 75

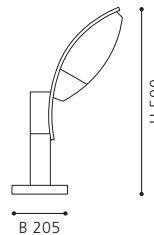

ET0725

93518 PANAMA 1



wall luminaire; cast aluminium, anthracite / plastic, white
Wandleuchte; Aluguss, anthrazit / Kunststoff, weiss
applique; aluminium moulé, anthracite / plastique, blanc

L 110, H 345, A 285

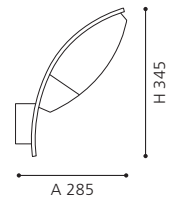
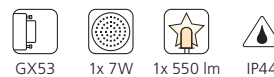

ET0725

L 630, B 110, H 2000, Base: B 200, T 200

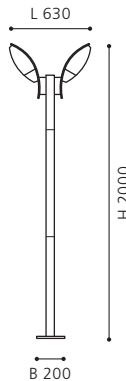

ET0725

LED



LED

30183 MOUNA

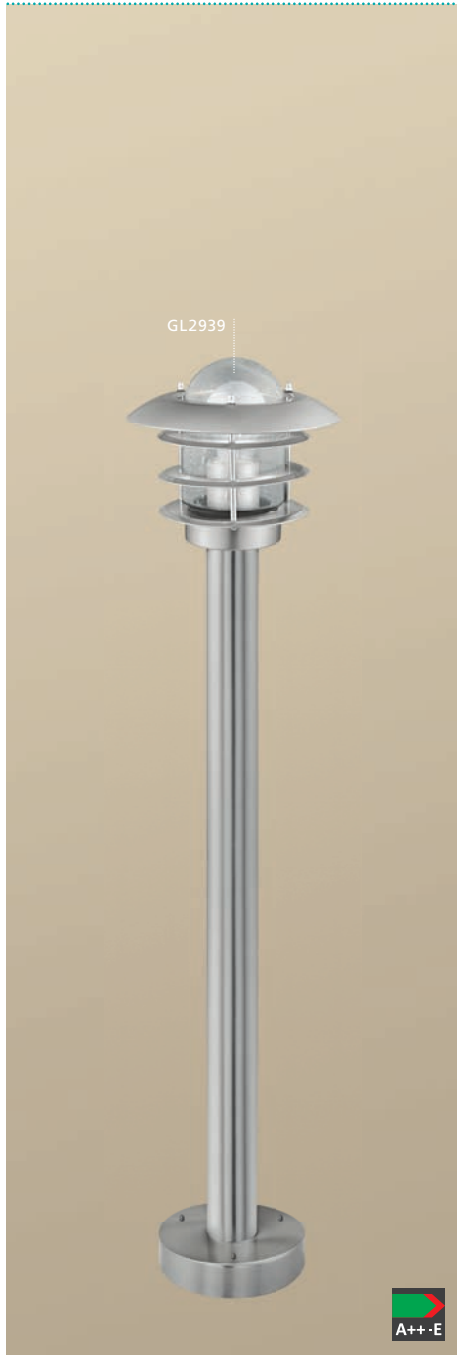

30182 MOUNA



floor luminaire; stainless steel, stainless steel / glass, clear
 Stehleuchte; Edelstahl, edelstahl / Glas, klar
 lampadaire; acier inoxydable, acier inoxydable / verre, clair

H 400, Ø 205, Base: Ø 150

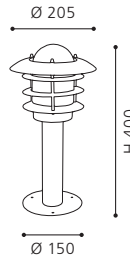

GL2939

30181 MOUNA

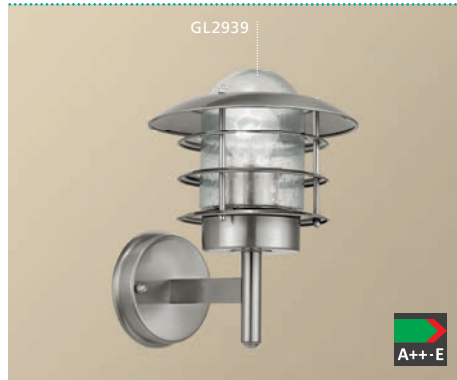

wall luminaire; stainless steel, stainless steel / glass, clear
 Wandleuchte; Edelstahl, edelstahl / Glas, klar
 applique; acier inoxydable, acier inoxydable / verre, clair

H 260, Ø 205, A 240

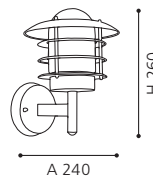

GL2939

94123 ARIOLLA

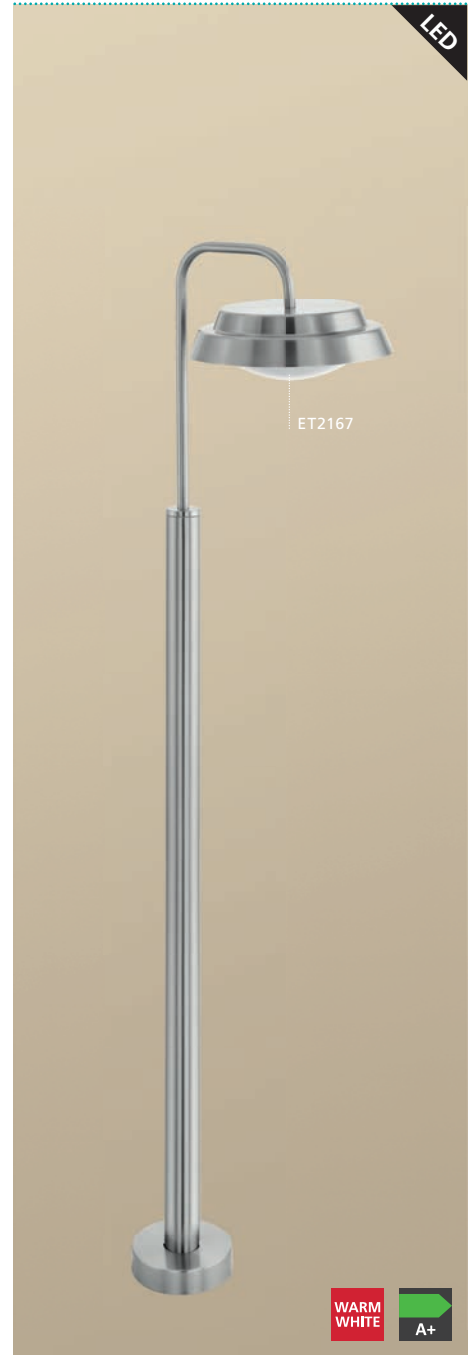

floor luminaire; stainless steel, stainless steel / plastic, white
 Stehleuchte; Edelstahl, edelstahl / Kunststoff, weiss
 lampadaire; acier inoxydable, acier inoxydable / plastique, blanc

H 1120, Ø 215

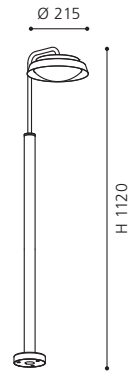

ET2167

H 950, Ø 205, Base: Ø 150

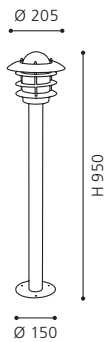

GL2939

94122 ARIOLLA



wall luminaire; stainless steel, stainless steel / plastic, white
Wandleuchte; Edelstahl, edelstahl / Kunststoff, weiss
applique; acier inoxydable, acier inoxydable / plastique, blanc

L 215, H 275, A 280

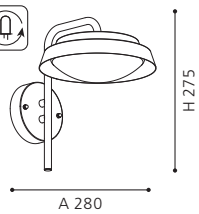

ET2167

93366 NISIA 1



wall luminaire; stainless steel, stainless steel / glass with wires, clear, aluminium
Wandleuchte; Edelstahl, edelstahl / Glas mit Draht, klar, alu
applique; acier inoxydable, acier inoxydable / verre avec fil, clair, aluminium

H 360, Ø 200, A 240

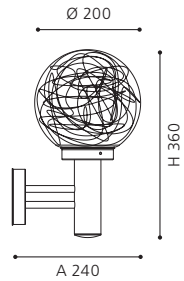

GL2968

93553 NISIA 1



floor luminaire; stainless steel, stainless steel / glass with wires, clear, aluminium
Stehleuchte; Edelstahl, edelstahl / Glas mit Draht, klar, alu
lampadaire; acier inoxydable, acier inoxydable / verre avec fil, clair, aluminium

H 500, Ø 200, Base: Ø 130

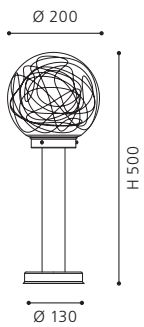
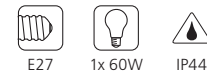

GL2968



30207 NISIA



floor luminaire; stainless steel, stainless steel /
satinated glass, white
Stehleuchte; Edelstahl, edelstahl /
Glas satiniert, weiss
lampadaire; acier inoxydable, acier inoxydable /
verre satiné, blanc

H 1000, Ø 200

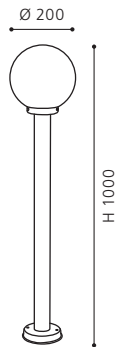

GL2852

27126 NISIA



wall luminaire; stainless steel, stainless steel /
glass, white
Wandleuchte; Edelstahl, edelstahl /
Glas, weiss
applique; acier inoxydable, acier inoxydable /
verre, blanc

H 343, Ø 200

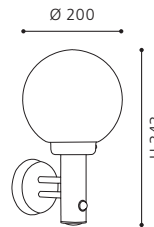

GL2852

30206 NISIA



floor luminaire; stainless steel, stainless steel /
satinated glass, white
Stehleuchte; Edelstahl, edelstahl /
Glas satiniert, weiss
lampadaire; acier inoxydable, acier inoxydable /
verre satiné, blanc

H 500, Ø 200, Base: Ø 130

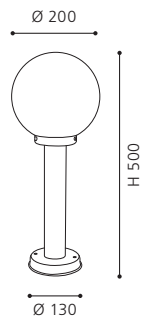

GL2852

30205 NISIA



wall luminaire; stainless steel, stainless steel /
satinated glass, white
Wandleuchte; Edelstahl, edelstahl /
Glas satiniert, weiss
applique; acier inoxydable, acier inoxydable /
verre satiné, blanc

L 200, H 360, A 240

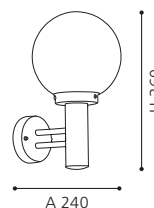

GL2852

89314 OHIO



wall luminaire; cast aluminium, stainless steel /
opal glass, white
Wandleuchte; Aluguss, edelstahl /
Glas opal-matt, weiss
applique; aluminium moulé, acier inoxydable /
verre opale, blanc

L 190, H 215, A 235

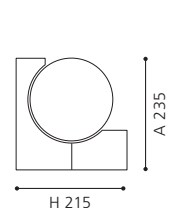

GL-805



89314

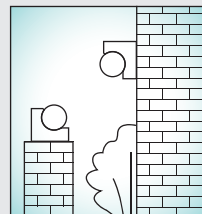

This luminaire is suitable for both wall and floor placement.

Diese Leuchte eignet sich sowohl zur Wand- als auch zur Bodenplatzierung.

Ce luminaire convient à la fixation au sol ou au mur.

LED

94848 SESIMBA



wall luminaire; galvanized steel, black / plastic, clear
Wandleuchte; Stahl verzinkt, schwarz / Kunststoff, klar
applique; acier galvanisé, noir / plastique, clair

94796 SESIMBA



wall luminaire; galvanized steel, silver / plastic, clear
Wandleuchte; Stahl verzinkt, silber / Kunststoff, klar
applique; acier galvanisé, argent / plastique, clair

94849 SESIMBA



wall luminaire; steel, white / plastic, clear
Wandleuchte; Stahl, weiss / Kunststoff, klar
applique; acier, blanc / plastique, clair

L 130, H 195, A 140

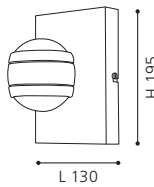

ET1902

L 130, H 195, A 140

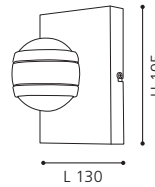
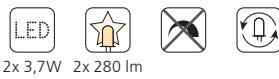

ET1902

L 130, H 195, A 140

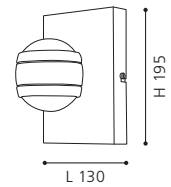
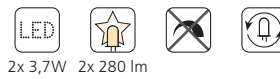

ET1902



SESIMBA

This luminaire is equipped with special lenses.

Diese Leuchte ist mit speziellen Linsen ausgestattet.

Ce luminaire est équipé avec des lentilles spécifiques.



94139 NOCELLA



wall luminaire; cast aluminium, silver / plastic, white
Wandleuchte; Aluguss, silber / Kunststoff, weiss
applique; aluminium moulé, argent / plastique, blanc

H 110, Ø 175, A 210

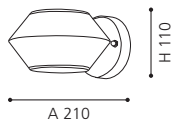
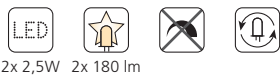

94141 NOCELLA



wall luminaire; cast aluminium, anthracite / plastic, white
Wandleuchte; Aluguss, anthrazit / Kunststoff, weiss
applique; aluminium moulé, anthracite / plastique, blanc

H 110, Ø 175, A 210

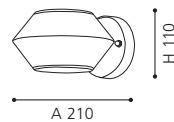

92382 NAGO



wall luminaire; galvanized steel, black
Wandleuchte; Stahl verzinkt, schwarz
applique; acier galvanisé, noir

L 110, H 115, A 145

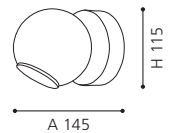
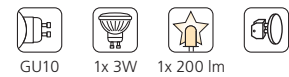

94089 LAVORIA



wall luminaire; galvanized steel, silver / plastic, white
Wandleuchte; Stahl verzinkt, silber / Kunststoff, weiss
applique; acier galvanisé, argent / plastique, blanc

L 140, H 130, A 180

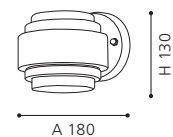

LED

93319 MORINO

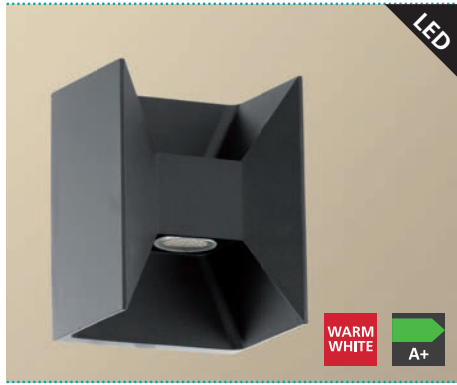

wall luminaire; cast aluminium, anthracite
Wandleuchte; Aluguss, anthrazit
applique; aluminium moulé, anthracite

93368 REDONDO



wall luminaire; cast aluminium, anthracite
Wandleuchte; Aluguss, anthrazit
applique; aluminium moulé, anthracite

93996 RUSTEGA

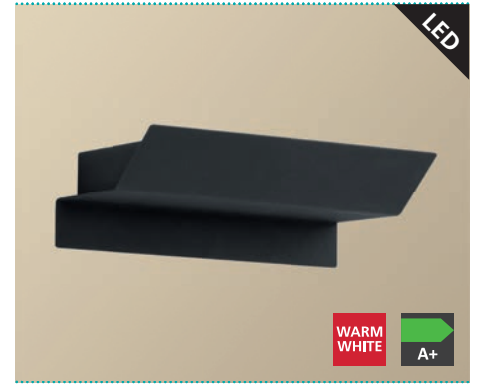

wall luminaire; galvanized steel, anthracite
Wandleuchte; Stahl verzinkt, anthrazit
applique; acier galvanisé, anthracite

L 140, H 180, A 105



9 002759 933197

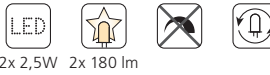

2x 2,5W 2x 180 lm



IP44

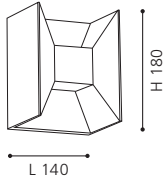

L 160, H 175, A 125



9 002759 933685

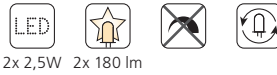

2x 2,5W 2x 180 lm



IP44

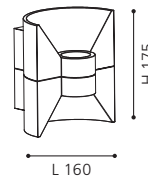

L 210, H 65, A 105



9 002759 939960



2x 2,5W 2x 180 lm



IP44

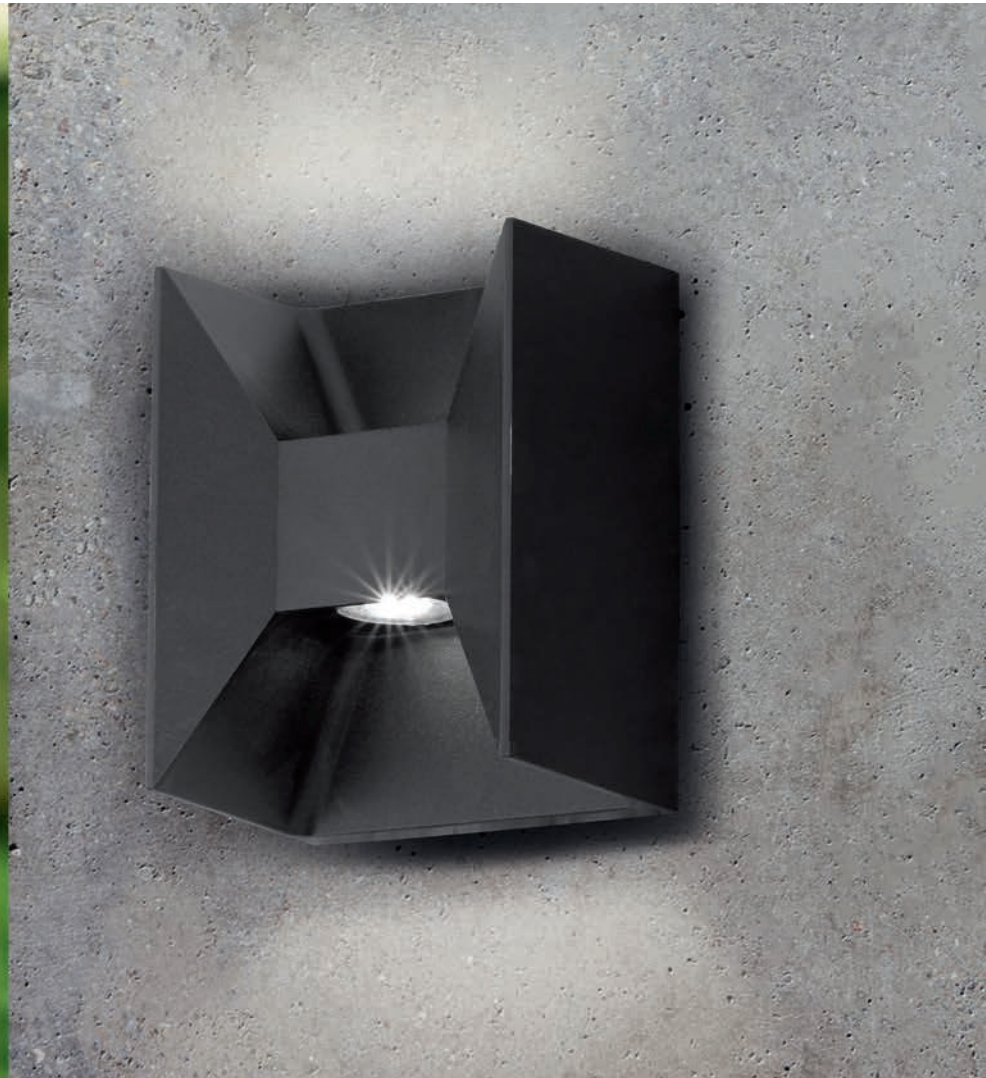
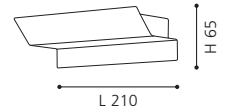

93318 MORINO



wall luminaire; cast aluminium, white
Wandleuchte; Aluguss, weiss
applique; aluminium moulé, blanc

L 140, H 180, A 105



2x 2,5W 2x 180 lm



IP44

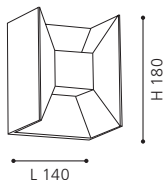

93367 REDONDO



wall luminaire; cast aluminium, white
Wandleuchte; Aluguss, weiss
applique; aluminium moulé, blanc

L 160, H 175, A 125



2x 2,5W 2x 180 lm



IP44

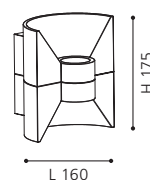

93255 FONTELA



wall luminaire; cast aluminium, white
Wandleuchte; Aluguss, weiss
applique; aluminium moulé, blanc

L 240, H 175, A 140



2x 2,5W 2x 180 lm



IP44

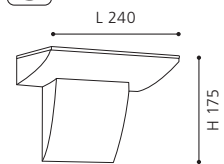

93317 PARDELA



wall luminaire; galvanized steel, white
Wandleuchte; Stahl verzinkt, weiss
applique; acier galvanisé, blanc

L 165, H 190, A 95



2x 2,5W 2x 180 lm



IP44

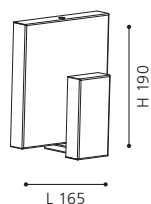

LED

93325 PIAS



wall luminaire; aluminium, white
Wandleuchte; Alu, weiss
applique; aluminium, blanc

93326 PIAS



wall luminaire; aluminium, white
Wandleuchte; Alu, weiss
applique; aluminium, blanc

93365 PIAS



wall luminaire; stainless steel, stainless steel
Wandleuchte; Edelstahl, edelstahl
applique; acier inoxydable, acier inoxydable

L 110, H 210, A 100



9 002759 933258



1x 2,5W 1x 160 lm



IP44

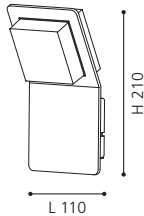

L 130, H 250, A 95



9 002759 933265



1x 2,5W 1x 180 lm 1x 2,5W 1x 160 lm



IP44

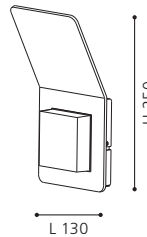

L 150, H 250, A 55



9 002759 933654



2x 2,5W 2x 160 lm



IP44

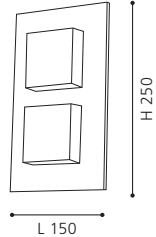

93326



This luminaire comes with lighting that is directed upwards as well.

Diese Leuchte strahlt auch nach oben.

Ce luminaire brille aussi vers le haut.

93356 TABO-LED



wall luminaire; stainless steel, stainless steel
Wandleuchte; Edelstahl, edelstahl
applique; acier inoxydable, acier inoxydable

L 75, H 305, A 85

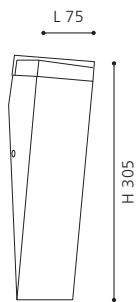
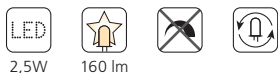

93364 TABO-LED



wall luminaire; stainless steel, stainless steel
Wandleuchte; Edelstahl, edelstahl
applique; acier inoxydable, acier inoxydable

L 80, H 195, A 110

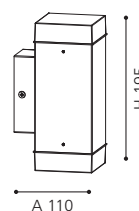

94114 CALGARY 1



wall luminaire; stainless steel, stainless steel / plastic, white
Wandleuchte; Edelstahl, edelstahl / Kunststoff, weiss
applique; acier inoxydable, acier inoxydable / plastique, blanc

L 200, H 200, A 95

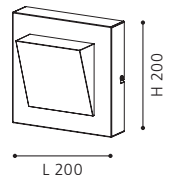

ET1811

93369 PARDELA 1



wall luminaire; stainless steel, stainless steel
Wandleuchte; Edelstahl, edelstahl
applique; acier inoxydable, acier inoxydable

L 170, H 280, A 100

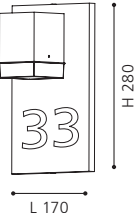

93369

1x A-F 3x 0-9

Letters and numbers included in delivery.

Buchstaben und Zahlen im Lieferumfang enthalten.

Les lettres et les nombres sont inclus dans la livraison.

LED

94793 ZAMORANA



wall luminaire; stainless steel, stainless steel
Wandleuchte; Edelstahl, edelstahl
applique; acier inoxydable, acier inoxydable

L 65, H 165, A 65

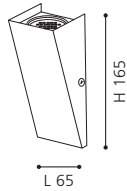
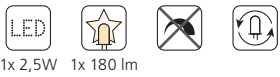

94794 ZAMORANA



wall luminaire; stainless steel, stainless steel
Wandleuchte; Edelstahl, edelstahl
applique; acier inoxydable, acier inoxydable

L 95, H 215, A 95

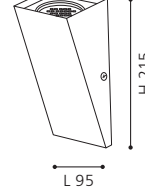

94851 ZAMORANA

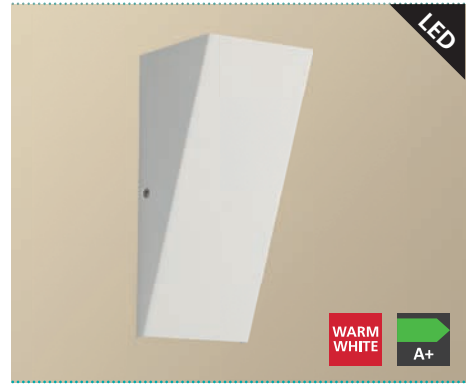

wall luminaire; galvanized steel, white
Wandleuchte; Stahl verzinkt, weiss
applique; acier galvanisé, blanc

L 95, H 215, A 95

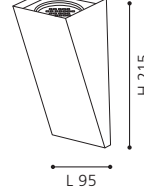
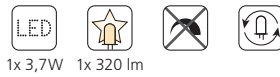

94184 TABO



ceiling luminaire; aluminium, silver
Deckenleuchte; Alu, silber
plafonnier; aluminium, argent

L 75, B 75, H 80

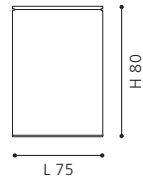

94185 TABO



wall luminaire; aluminium, silver
Wandleuchte; Alu, silber
applique; aluminium, argent

L 75, B 75, H 140, A 105

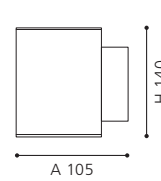

94186 TABO



wall luminaire; aluminium, silver
Wandleuchte; Alu, silber
applique; aluminium, argent

L 75, B 75, H 195, A 105

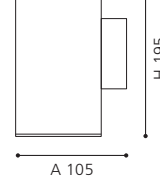

LED



ZAMORANO



This luminaire is suitable for up- and downward placement.

Diese Leuchte kann sowohl nach oben als auch nach unten strahlend montiert werden.

Ce luminaire peut être installé vers le haut ou vers le bas, selon l'effet lumineux désiré.

LED

93994 PREDAZZO

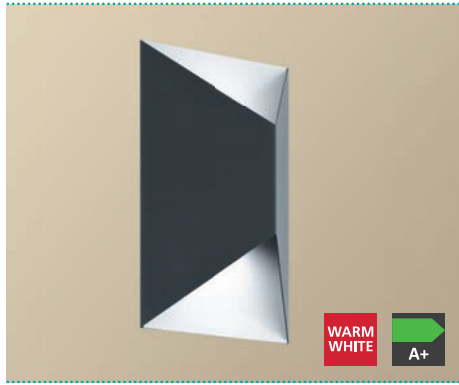

wall luminaire; galvanized steel, anthracite, white
Wandleuchte; Stahl verzinkt, anthrazit, weiss
applique; acier galvanisé

L 140, H 210, A 75

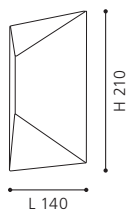

93993 PREDAZZO

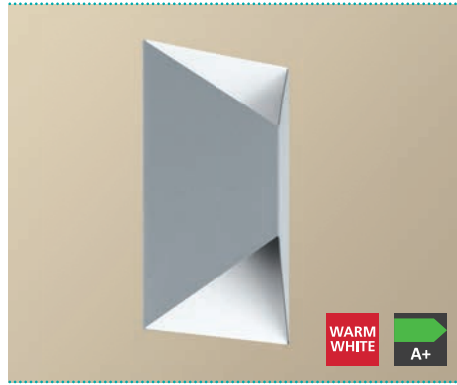

wall luminaire; galvanized steel, silver, white
Wandleuchte; Stahl verzinkt, silber, weiss
applique; acier galvanisé, argent, blanc

L 140, H 210, A 75

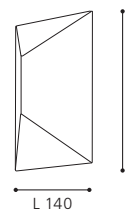
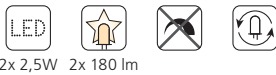

91096 MORINO



wall / ceiling luminaire; cast aluminium, silver, white
Wand- / Deckenleuchte; Aluguss, silber, weiss
applique / plafonnier; aluminium moulé, argent, blanc

L 140, H 280, A 125

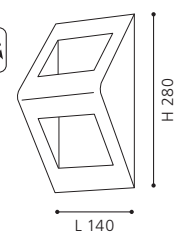

93253 KIBEA

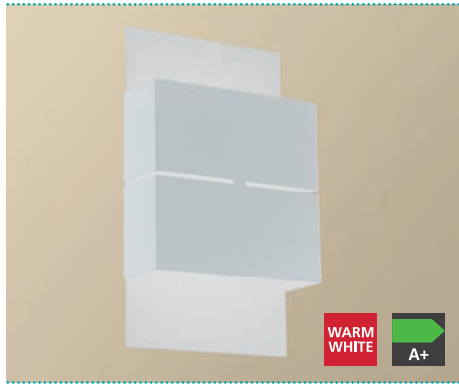

wall luminaire; galvanized steel, white
Wandleuchte; Stahl verzinkt, weiss
applique; acier galvanisé, blanc

L 150, H 260, A 75

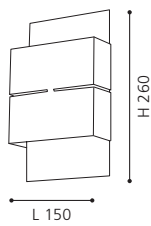

93254 KIBEA



wall luminaire; galvanized steel, white, anthracite
Wandleuchte; Stahl verzinkt, weiss, anthrazit
applique; acier galvanisé, blanc, anthracite

L 150, H 260, A 75

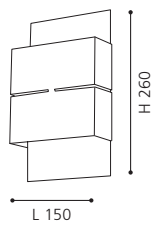
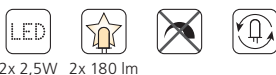

93438 NADELA



wall luminaire; stainless steel, stainless steel /
satinated glass, white
Wandleuchte; Edelstahl, edelstahl /
Glas satiniert, weiss
applique; acier inoxydable, acier inoxydable /
verre satiné, blanc

L 215, H 290, A 90

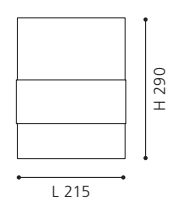

GL3026

LED



LED

94871 SONELLA

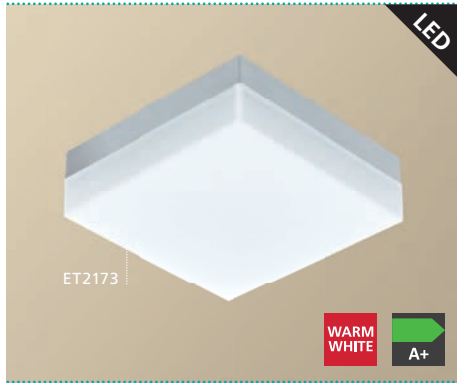

wall / ceiling luminaire; plastic, white /
plastic, white
Wand- / Deckenleuchte; Kunststoff, weiss /
Kunststoff, weiss
applique / plafonnier; plastique, blanc /
plastique, blanc

L 215, H 215, A 70



9 002759 948719



8,2W 820 lm



IP44

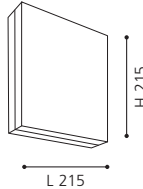

ET2173

94872 SONELLA



wall / ceiling luminaire; plastic, anthracite /
plastic, white
Wand- / Deckenleuchte; Kunststoff, anthrazit /
Kunststoff, weiss
applique / plafonnier; plastique, anthracite /
plastique, blanc

L 215, H 215, A 70



9 002759 948726



8,2W 820 lm



IP44

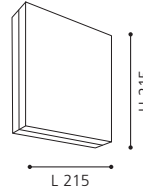

ET2173

94876 SONELLA 1

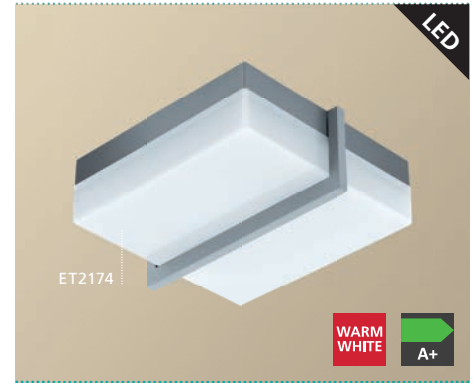

wall / ceiling luminaire; plastic, aluminium, anthracite /
plastic, white
Wand- / Deckenleuchte; Kunststoff, Alu, anthrazit /
Kunststoff, weiss
applique / plafonnier; plastique, aluminium, anthracite /
plastique, blanc

L 215, H 240, A 85



9 002759 948764



8,2W 820 lm



IP44

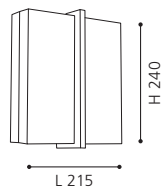

ET2174

94877 INFESTO 1



wall / ceiling luminaire; stainless steel, plastic, stainless steel,
silver / plastic, white
Wand- / Deckenleuchte; Edelstahl, Kunststoff, edelstahl,
silber / Kunststoff, weiss
applique / plafonnier; acier inoxydable, plastique, acier inoxy-
dable, argent / plastique, blanc

L 250, H 250, A 70



9 002759 948771



8,2W 820 lm



IP44

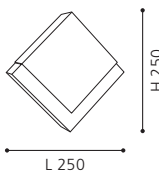

ET2173

94874 INFESTO



wall / ceiling luminaire; plastic, steel, silver /
glass, plastic, clear, anthracite
Wand- / Deckenleuchte; Kunststoff, Stahl, silber /
Glas, Kunststoff, klar, anthrazit
applique / plafonnier; plastique, acier, argent /
verre, plastique, clear, anthracite

L 250, H 250, A 85



9 002759 948740



8,2W 820 lm



IP44

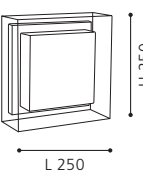

ET2173

LED



93437 NADELA



wall luminaire; stainless steel, stainless steel
Wandleuchte; Edelstahl, edelstahl
applique; acier inoxydable, acier inoxydable

L 225, H 125, A 90



94117 CORFINO



wall luminaire; galvanized steel, silver
Wandleuchte; Stahl verzinkt, silber
applique; acier galvanisé, argent

L 265, H 210, A 85



91769 VOLPINO



wall luminaire; galvanized steel, silver / plastic, white
Wandleuchte; Stahl verzinkt, silber / Kunststoff, weiss
applique; acier galvanisé, argent / plastique, blanc

L 290, H 115, A 60



94845 ACATE



wall / ceiling luminaire; aluminium, steel, silver / plastic, white
Wand- / Deckenleuchte; Alu, Stahl, silber / Kunststoff, weiss
applique / plafonnier; aluminium, acier, argent / plastique, blanc

L 100, H 350, A 60

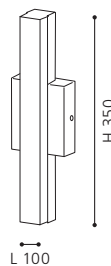
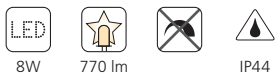

ET2168

94398 MIRANO



wall luminaire; galvanized steel, silver / satinated glass, white, clear
Wandleuchte; Stahl verzinkt, silber / Glas satiniert, weiss, klar
applique; acier galvanisé, argent / verre satiné, blanc, clair

L 180, H 330, A 60

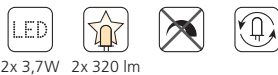

GL3449, ET2162

89366 ARCHA



wall luminaire; cast aluminium, stainless steel, satin nickel / corroded glass, white
Wandleuchte; Aluguss, edelstahl, nickel-matt / Glas geätzt, weiss
applique; aluminium moulé, acier inoxydable, nickel mat / verre rouillé, blanc

L 220, H 330, A 112

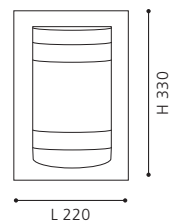
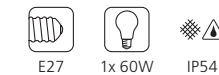

GL2073



89366

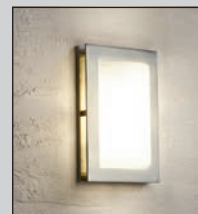

This luminaire comes with adjustable design elements made of stainless steel.

Diese Leuchte wird mit verstellbaren Zierelementen aus Edelstahl geliefert.

Ce luminaire vient avec éléments de décoration interchangeables en acier inoxydable.

LED

94133 MALGERA



wall luminaire; galvanized steel, silver / plastic, white
 Wandleuchte; Stahl verzinkt, silber / Kunststoff, weiss
 applique; acier galvanisé, argent / plastique, blanc

L 170, H 270, A 115

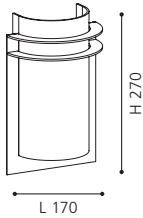

ET1814

94138 BREGANZO



wall luminaire; galvanized steel, anthracite / plastic, white
 Wandleuchte; Stahl verzinkt, anthrazit / Kunststoff, weiss
 applique; acier galvanisé, anthracite / plastique, blanc

L 180, H 250, A 115

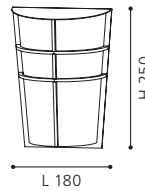

IP44

94137 BREGANZO



wall luminaire; galvanized steel, silver / plastic, white
 Wandleuchte; Stahl verzinkt, silber / Kunststoff, weiss
 applique; acier galvanisé, argent / plastique, blanc

L 180, H 250, A 115

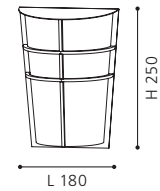

IP44

87184 PARK 5



wall luminaire; cast aluminium, anthracite / satinated glass, white
 Wandleuchte; Aluguss, anthrazit / Glas satiniert, weiss
 applique; aluminium moulé, anthracite / verre satiné, blanc

L 200, H 350, A 100

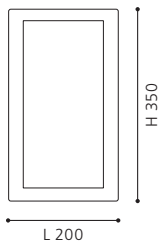

GL-804

83433 PARK



wall luminaire; cast aluminium, anthracite / satinated glass, white
 Wandleuchte; Aluguss, anthrazit / Glas satiniert, weiss
 applique; aluminium moulé, anthracite / verre satiné, blanc

L 200, H 350, A 145

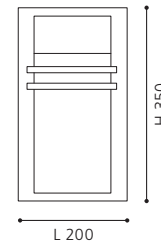

GL-803

83432 PARK



wall luminaire; cast aluminium, silver / satinated glass, white
 Wandleuchte; Aluguss, silber / Glas satiniert, weiss
 applique; aluminium moulé, argent / verre satiné, blanc

L 200, H 350, A 145

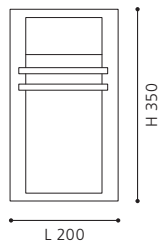

GL-803

LED



LED



94213 CITY LED

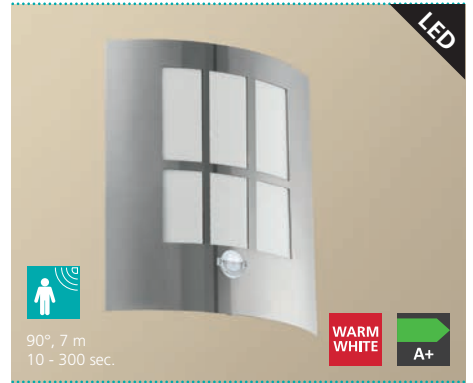

90°, 7 m
10 - 300 sec.

wall luminaire; stainless steel, stainless steel / plastic, white
Wandleuchte; Edelstahl, edelstahl / Kunststoff, weiss
applique; acier inoxydable, acier inoxydable / plastique, blanc

L 235, H 260, A 90

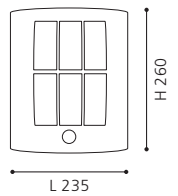
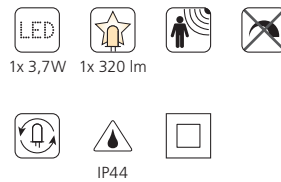

94212 CITY LED



wall luminaire; stainless steel, stainless steel / plastic, white
Wandleuchte; Edelstahl, edelstahl / Kunststoff, weiss
applique; acier inoxydable, acier inoxydable / plastique, blanc

L 235, H 260, A 90

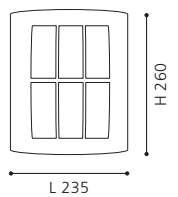
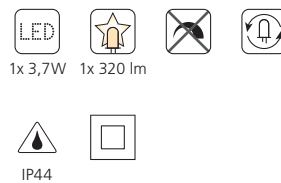

88144 CITY



wall luminaire; stainless steel, stainless steel / plastic, white
Wandleuchte; Edelstahl, edelstahl / Kunststoff, weiss
applique; acier inoxydable, acier inoxydable / plastique, blanc

L 235, H 260, A 90

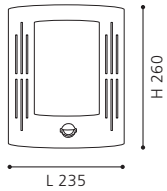
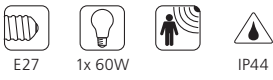

ET0614

88142 CITY

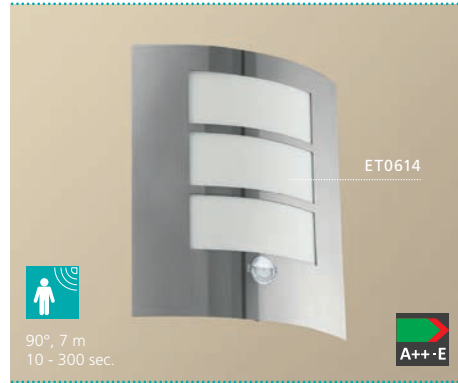

wall luminaire; stainless steel, stainless steel / plastic, white
Wandleuchte; Edelstahl, edelstahl / Kunststoff, weiss
applique; acier inoxydable, acier inoxydable / plastique, blanc

L 235, H 260, A 90

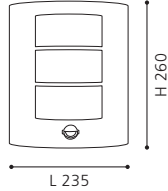
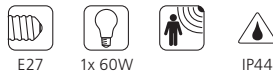

ET0614

30194 CITY 1

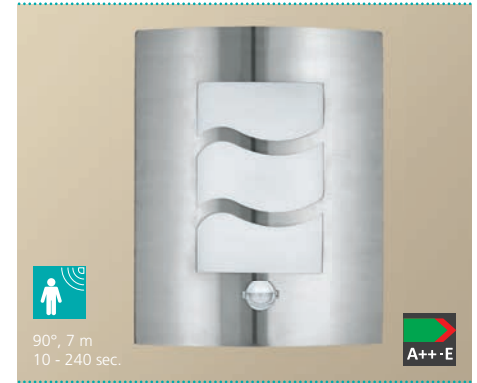

wall luminaire; stainless steel, stainless steel / plastic, white
Wandleuchte; Edelstahl, edelstahl / Kunststoff, weiss
applique; acier inoxydable, acier inoxydable / plastique, blanc

L 230, H 300, A 90

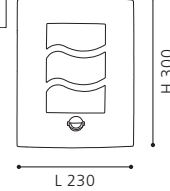
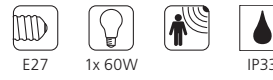

ET0614

82309 CITY



wall luminaire; stainless steel, stainless steel / plastic, white
Wandleuchte; Edelstahl, edelstahl / Kunststoff, weiss
applique; acier inoxydable, acier inoxydable / plastique, blanc

L 235, H 260, A 90

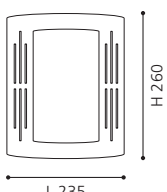
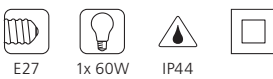

ET0234

88139 CITY



wall luminaire; stainless steel, stainless steel / plastic, white
Wandleuchte; Edelstahl, edelstahl / Kunststoff, weiss
applique; acier inoxydable, acier inoxydable / plastique, blanc

L 235, H 260, A 90

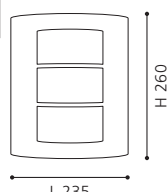
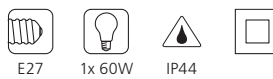

ET0234

30193 CITY 1

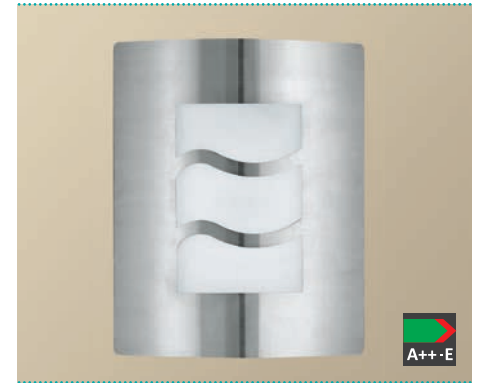

wall luminaire; stainless steel, stainless steel / plastic, white
Wandleuchte; Edelstahl, edelstahl / Kunststoff, weiss
applique; acier inoxydable, acier inoxydable / plastique, blanc

L 230, H 300, A 90

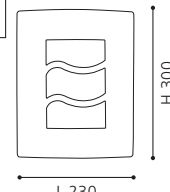
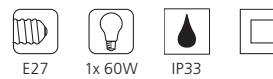

ET0614

LED

30191 CERNO



GL2890



wall luminaire; stainless steel, stainless steel / satinated glass, white
Wandleuchte; Edelstahl, edelstahl / Glas satiniert, weiss
applique; acier inoxydable, acier inoxydable / verre satiné, blanc

L 140, H 165, A 105

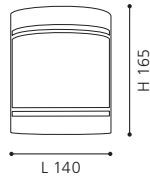

GL2890

30192 CERNO



GL2890



90°, 7 m
 10 - 240 sec.

wall luminaire; stainless steel, stainless steel / satinated glass, white
Wandleuchte; Edelstahl, edelstahl / Glas satiniert, weiss
applique; acier inoxydable, acier inoxydable / verre satiné, blanc

L 140, H 190, A 110

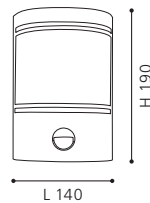

GL2890

30173 DARIL



wall luminaire; stainless steel, stainless steel / plastic, clear
Wandleuchte; Edelstahl, edelstahl / Kunststoff, klar
applique; acier inoxydable, acier inoxydable / plastique, clair

L 195, H 240, A 110

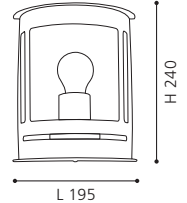

94797 CERNO

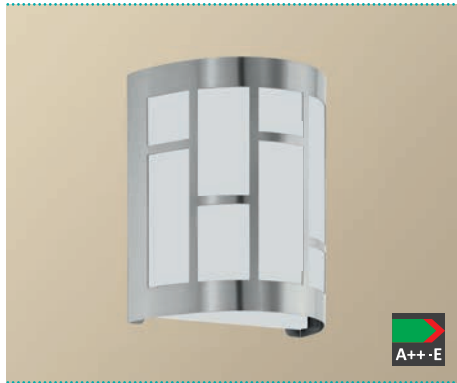

wall luminaire; stainless steel, stainless steel / satinated glass, white
Wandleuchte; Edelstahl, edelstahl / Glas satiniert, weiss
applique; acier inoxydable, acier inoxydable / verre satiné, blanc

L 135, H 165, A 105

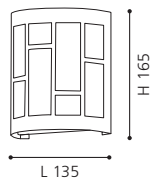

94798 CERNO



GL2890



90°, 7 m
 10 - 240 sec.

wall luminaire; stainless steel, stainless steel / satinated glass, white
Wandleuchte; Edelstahl, edelstahl / Glas satiniert, weiss
applique; acier inoxydable, acier inoxydable / verre satiné, blanc

L 135, H 200, A 105

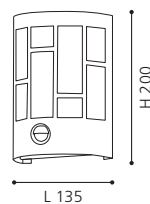

GL2890

94086 RALORA



LED



WARM WHITE

wall luminaire; stainless steel, stainless steel / plastic, white
Wandleuchte; Edelstahl, edelstahl / Kunststoff, weiss
applique; acier inoxydable, acier inoxydable / plastique, blanc

L 140, H 240, A 70

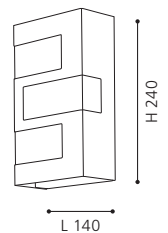
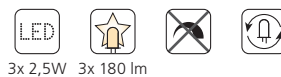



95073 TRABADA



wall luminaire; cast aluminium, white / plastic, white
 Wandleuchte; Aluguss, weiss / Kunststoff, weiss
 applique; aluminium moulé, blanc / plastique, blanc

L 160, H 190, A 115

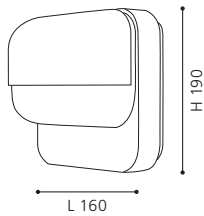

94852 TRABADA



wall luminaire; cast aluminium, black / plastic, white
 Wandleuchte; Aluguss, schwarz / Kunststoff, weiss
 applique; aluminium moulé, noir / plastique, blanc

L 160, H 190, A 115

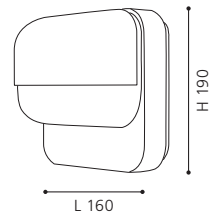
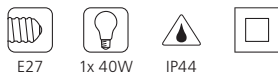

95074 TRABADA



wall luminaire; cast aluminium, white / plastic, white
 Wandleuchte; Aluguss, weiss / Kunststoff, weiss
 applique; aluminium moulé, blanc / plastique, blanc

L 160, H 190, A 115

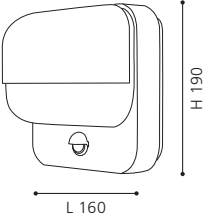

94853 TRABADA



wall luminaire; cast aluminium, black / plastic, white
 Wandleuchte; Aluguss, schwarz / Kunststoff, weiss
 applique; aluminium moulé, noir / plastique, blanc

L 160, H 190, A 115

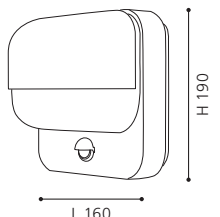



LED

86248 KONYA



pedestal luminaire; stainless steel, stainless steel / satinated glass, white
Sockelleuchte; Edelstahl, edelstahl / Glas satiniert, weiss
borne; acier inoxydable, acier inoxydable / verre satiné, blanc

H 350, Base: Ø 90

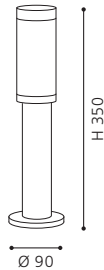
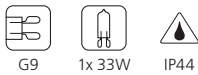

GL1073

86385 KONYA

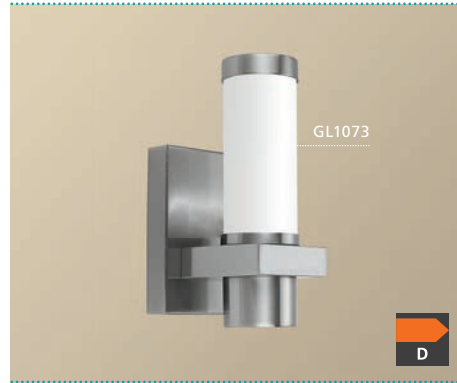

wall luminaire; stainless steel, stainless steel / satinated glass, white
Wandleuchte; Edelstahl, edelstahl / Glas satiniert, weiss
applique; acier inoxydable, acier inoxydable / verre satiné, blanc

L 80, H 215, A 120

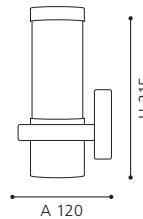
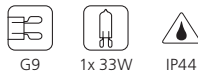

GL1073

94124 BENACO

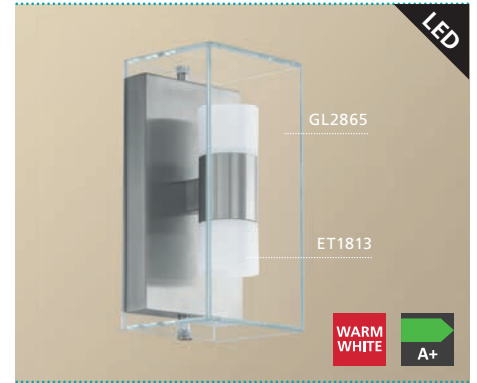

wall luminaire; stainless steel, stainless steel / glass, plastic, clear, white
Wandleuchte; Edelstahl, edelstahl / Glas, Kunststoff, klar, weiss
applique; acier inoxydable, acier inoxydable / verre, plastique, clair, blanc

L 130, H 250, A 110

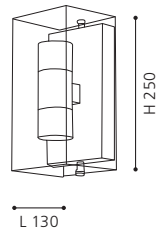

GL2865, ET1813

94119 RAVARINO



wall luminaire; aluminium, silver / plastic, white
Wandleuchte; Alu, silber / Kunststoff, weiss
applique; aluminium, argent / plastique, blanc

L 140, H 270, A 110

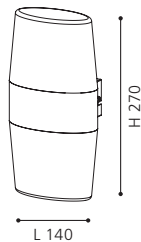
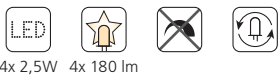

GL1073

86541 BEVERLY

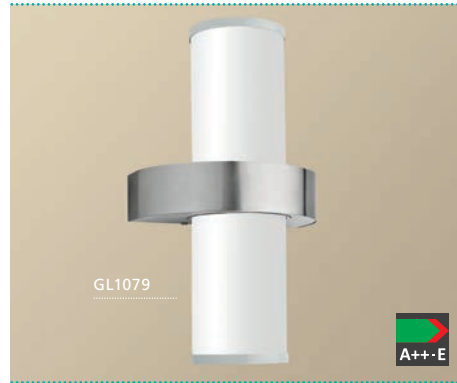

wall luminaire; stainless steel, stainless steel, silver / satinated glass, white
Wandleuchte; Edelstahl, edelstahl, silber / Glas satiniert, weiss
applique; acier inoxydable, acier inoxydable, argent / verre satiné, blanc

L 200, H 350, A 135

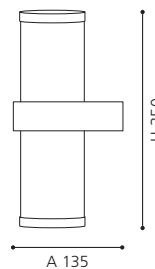

GL1079

92342 BENACO



wall luminaire; stainless steel, stainless steel / glass, clear, white
Wandleuchte; Edelstahl, edelstahl / Glas, klar, weiss
applique; acier inoxydable, acier inoxydable / verre, clair, blanc

L 130, H 250, A 110

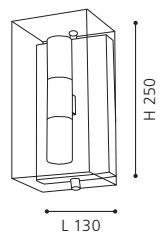
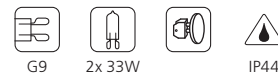

GL2865, GL2866



LED

94779 BOSARO



wall luminaire; stainless steel, stainless steel
Wandleuchte; Edelstahl, edelstahl
applique; acier inoxydable, acier inoxydable

L 170, H 270, A 105

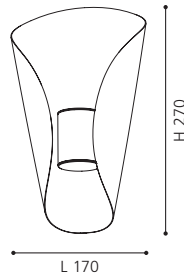

93991 BOSARO



wall luminaire; galvanized steel, white
Wandleuchte; Stahl verzinkt, weiss
applique; acier galvanisé, blanc

L 170, H 270, A 105

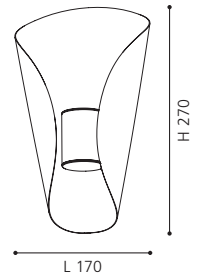

93256 SOJO



wall luminaire; galvanized steel, white
Wandleuchte; Stahl verzinkt, weiss
applique; acier galvanisé, blanc

L 180, H 265, A 135

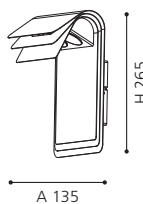

93999 FASTRO 1



wall luminaire; stainless steel, stainless-steel, white
Wandleuchte; Edelstahl, edelstahl, weiss
applique; acier inoxydable, stainless-steel, white

L 160, H 220, A 90

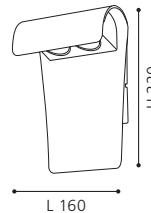

93998 FASTRO



wall luminaire; stainless steel, stainless-steel, white
Wandleuchte; Edelstahl, edelstahl, weiss
applique; acier inoxydable, stainless-steel, white

L 215, H 220, A 105

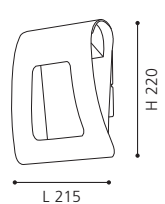

LED



94784 ONTANEDA



ET1537

WARM WHITE A+

wall / ceiling luminaire; plastic, black / plastic, white
Wand- / Deckenleuchte; Kunststoff, schwarz / Kunststoff, weiss
applique / plafonnier; plastique, noir / plastique, blanc

Ø 325, A 75



9 002759 947842



8,2W 820 lm

IP44

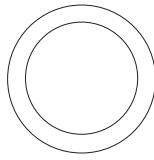

Ø 325

ET1537

94785 ONTANEDA



ET1537

WARM WHITE A+

wall / ceiling luminaire; plastic, white / plastic, white
Wand- / Deckenleuchte; Kunststoff, weiss / Kunststoff, weiss
applique / plafonnier; plastique, blanc / plastique, blanc

Ø 325, A 75



9 002759 947859



8,2W 820 lm

IP44

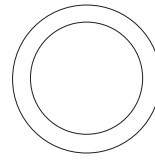

Ø 325

ET1537

93267 CITY 2



WARM WHITE A+

wall / ceiling luminaire; stainless steel, stainless steel / plastic, white
Wand- / Deckenleuchte; Edelstahl, edelstahl / Kunststoff, weiss
applique / plafonnier; acier inoxydable, acier inoxydable / plastique, blanc

Ø 280, A 60



9 002759 932671



GX53 1x 7W 1x 550 lm

IP44



Ø 280

ET1537

30907 VENTO 1



GL1610

WARM WHITE A++

wall / ceiling luminaire; galvanized steel, anthracite / satinized glass, white
Wand- / Deckenleuchte; Stahl verzinkt, anthrazit / Glas satiniert, weiss
applique / plafonnier; acier galvanisé, anthracite / verre satiné, blanc

Ø 185, A 60



9 002759 309077



GX53 1x 3,7W 1x 330 lm

IP44

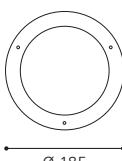

Ø 185

GL1610

94091 VENTO



GL1610

WARM WHITE A++

wall / ceiling luminaire; stainless steel, stainless steel / satinized glass, white
Wand- / Deckenleuchte; Edelstahl, edelstahl / Glas satiniert, weiss
applique / plafonnier; acier inoxydable, acier inoxydable / verre satiné, blanc

Ø 185, A 60



9 002759 940911



GX53 1x 3,7W 1x 330 lm

IP44

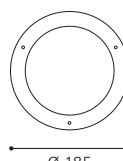

Ø 185

GL1610

94121 VENTO 1



GL3180

WARM WHITE A+

wall / ceiling luminaire; stainless steel, stainless steel / glass, coated white
Wand- / Deckenleuchte; Edelstahl, edelstahl / Glas, weiss lackiert
applique / plafonnier; acier inoxydable, acier inoxydable / verre, blanc laqué

Ø 285, A 80



9 002759 941215



3x 2,5W 3x 180 lm

IP44

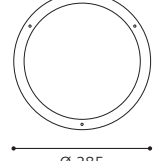

Ø 285

GL3180

LED

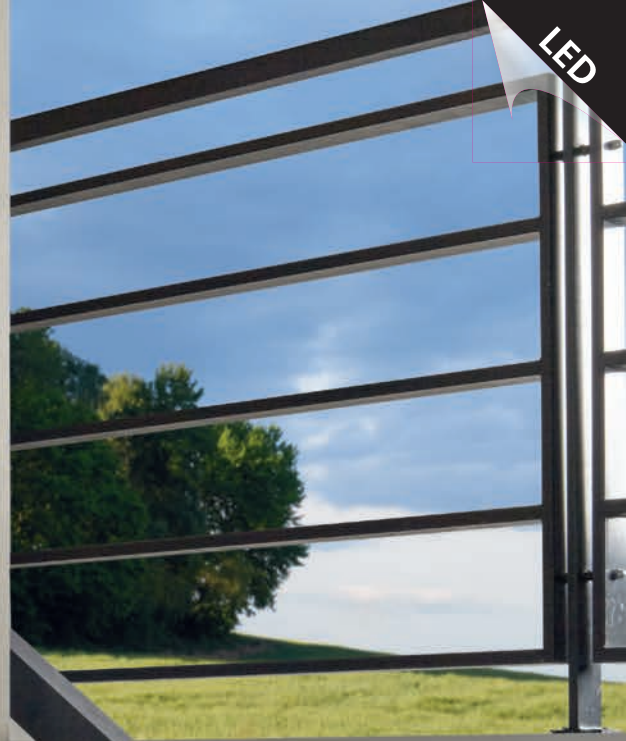

LED

89768 ONJA



wall luminaire; cast aluminium, white / ribbed glass, clear
Wandleuchte; Aluguss, weiss / Glas geriffelt, klar
applique; aluminium moulé, blanc / verre strié, clair

89769 ONJA



wall luminaire; cast aluminium, silver / ribbed glass, clear
Wandleuchte; Aluguss, silber / Glas geriffelt, klar
applique; aluminium moulé, argent / verre strié, clair

89767 ONJA



wall luminaire; cast aluminium, black / ribbed glass, clear
Wandleuchte; Aluguss, schwarz / Glas geriffelt, klar
applique; aluminium moulé, noir / verre strié, clair

L 220, H 155, A 150

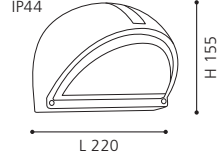

GL2440

L 220, H 155, A 150

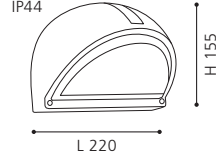

GL2440

L 220, H 155, A 150

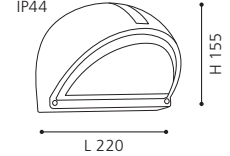

GL2440

93258 ISOBA



wall luminaire; cast aluminium, white / plastic, white
Wandleuchte; Aluguss, weiss / Kunststoff, weiss
applique; aluminium moulé, blanc / plastique, blanc

93259 ISOBA



wall luminaire; cast aluminium, silver / plastic, white
Wandleuchte; Aluguss, silber / Kunststoff, weiss
applique; aluminium moulé, argent / plastique, blanc

L 160, H 220, A 100

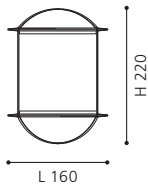

L 160, H 220, A 100

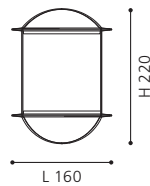



LED

93261 SIONES



wall / ceiling luminaire; cast aluminium, white / structured glass, white
Wand- / Deckenleuchte; Aluguss, weiss / Glas mit Struktur, weiss
applique / plafonnier; aluminium moulé, blanc / verre structuré, blanc

L 145, H 215, A 100



9 002759 932619

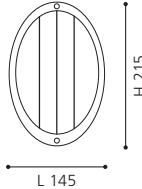

GL2972

93263 SIONES



wall / ceiling luminaire; cast aluminium, white / structured glass, white
Wand- / Deckenleuchte; Aluguss, weiss / Glas mit Struktur, weiss
applique / plafonnier; aluminium moulé, blanc / verre structuré, blanc

Ø 260, A 100



9 002759 932633

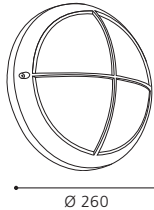

GL2971

88807 ANOLA



wall / ceiling luminaire; plastic, white / glass, clear
Wand- / Deckenleuchte; Kunststoff, weiss / Glas, klar
applique / plafonnier; plastique, blanc / verre, clair

Ø 185, A 100



9 002759 888077

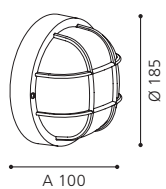
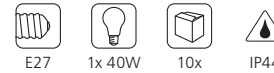

GL2971

93262 SIONES

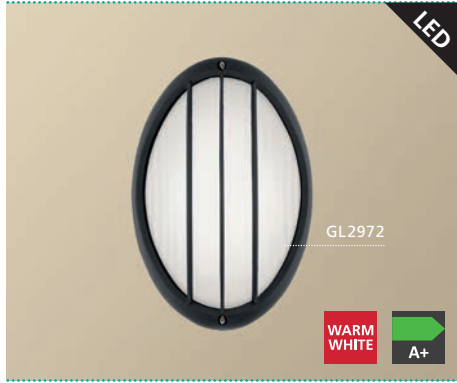

wall / ceiling luminaire; cast aluminium, black / structured glass, white
Wand- / Deckenleuchte; Aluguss, schwarz / Glas mit Struktur, weiss
applique / plafonnier; aluminium moulé, noir / verre structuré, blanc

L 145, H 215, A 100



9 002759 932626

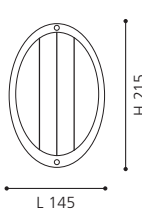

GL2972

93264 SIONES



wall / ceiling luminaire; cast aluminium, black / structured glass, white
Wand- / Deckenleuchte; Aluguss, schwarz / Glas mit Struktur, weiss
applique / plafonnier; aluminium moulé, noir / verre structuré, blanc

Ø 260, A 100



9 002759 932640

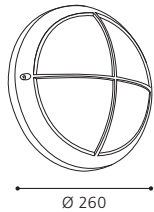

GL2971

88803 ANOLA

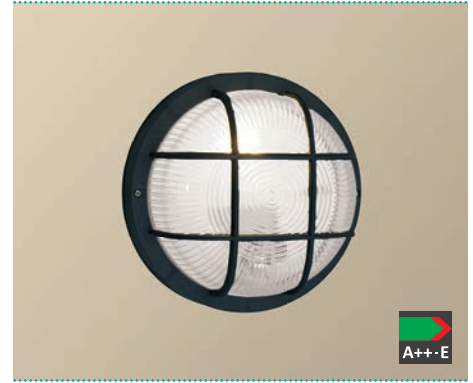

wall / ceiling luminaire; plastic, black / glass, clear
Wand- / Deckenleuchte; Kunststoff, schwarz / Glas, klar
applique / plafonnier; plastique, noir / verre, clair

Ø 185, A 100



9 002759 888039

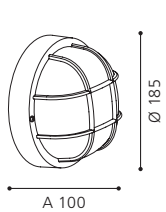
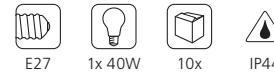

GL2971

88806 ANOLA



wall / ceiling luminaire; plastic, white / glass, clear
 Wand- / Deckenleuchte; Kunststoff, weiss / Glas, klar
 applique / plafonnier; plastique, blanc / verre, clair

L 203, B 113, A 94



E27



1x 40W



10x



IP44

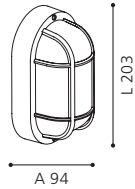

88802 ANOLA



wall / ceiling luminaire; plastic, black / glass, clear
 Wand- / Deckenleuchte; Kunststoff, schwarz / Glas, klar
 applique / plafonnier; plastique, noir / verre, clair

L 203, B 113, A 94



E27



1x 40W



10x



IP44

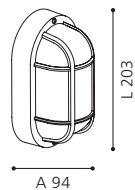

88489 MILTON



wall luminaire; steel, hot-dip galvanised / glass, clear
Wandleuchte; Stahl, feuerverzinkt / Glas, klar
applique; acier, galvanisé à chaud / verre, clair

H 310, A 310

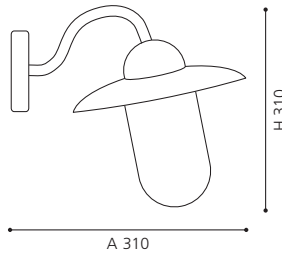

GL-859

88119 SEVILLA



wall / ceiling luminaire; steel, hot-dip galvanised / satinated glass, white
Wand- / Deckenleuchte; Stahl, feuerverzinkt / Glas satiniert, weiss
applique / plafonnier; acier, galvanisé à chaud / verre satiné, blanc

Ø 285, A 83

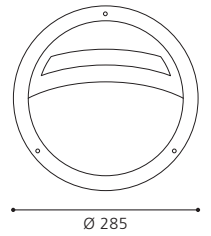

GL1611

88487 CITY



wall luminaire; stainless steel, hot-dip galvanised / plastic, white
Wandleuchte; Edelstahl, feuerverzinkt / Kunststoff, weiss
applique; acier inoxydable, galvanisé à chaud / plastique, blanc

L 235, H 260, A 90

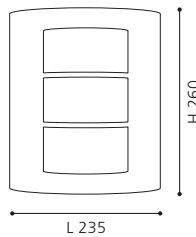

ET0234

90867 LEPUS



wall luminaire; steel, hot-dip galvanised / plastic, white
Wandleuchte; Stahl, feuerverzinkt / Kunststoff, weiss
applique; acier, galvanisé à chaud / plastique, blanc

L 235, H 120, A 125

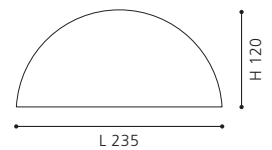

ET1602



15 years guarantee against corrosion on the hot dipped galvanized surface.

15 Jahre Garantie gegen Korrosion der feuerverzinkten Oberfläche.

Garantie de 15 ans contre la corrosion de surface galvanisé à chaud.



Classic

Overview



ALAMONTE
p. 66



ALAMONTE 1
p. 68



COLINDRES
p. 70



BARROSELA
p. 70



COLINDRES 1
p. 71



MELGOA
p. 71



HILBURN 1
p. 72



HILBURN
p. 74



PULFERO
p. 76



PULFERO 1
p. 78



ALORIA
p. 81



ALORIA
p. 83



ALORIA-LED
p. 84



ALORIA-LED
p. 84



PATERNO
p. 86



LISIO
p. 88



EXIT 1
p. 89



SIDNEY
p. 90



SIDNEY
p. 91



BUCKINGHAM
p. 92



NABILA 1
p. 92



RAIANO
p. 92



MINORCA
p. 93



MILTON 1
p. 94



MILTON
p. 94



LATERNA 7
p. 94



SAN TELMO
p. 95



PORTICI
p. 95



CITY CLASSIC
p. 95



LATERNA 7
p. 95



NAVEDO
p. 97



NAVEDO
p. 100



LATERNA 5
p. 103



LATERNA 4
p. 104



OUTDOOR CLASSIC
p. 107

94829 ALAMONTE



floor luminaire; stainless steel, stainless steel / glass, clear
Stehleuchte; Edelstahl, edelstahl / Glas, klar
lampadaire; acier inoxydable, acier inoxydable / verre, clair

L 150, B 150, H 1015, Base: Ø 110

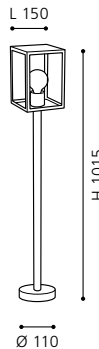

GL3394

94786 ALAMONTE



pendant luminaire; stainless steel, stainless steel / glass, clear
Hängeleuchte; Edelstahl, edelstahl / Glas, klar
luminaire suspension; acier inoxydable, acier inoxydable / verre, clair

L 150, B 150, H 1285

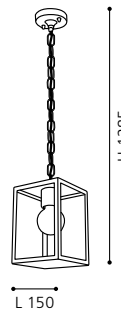

GL3394, GL3395

94827 ALAMONTE



wall luminaire; stainless steel, stainless steel / glass, clear
Wandleuchte; Edelstahl, edelstahl / Glas, klar
applique; acier inoxydable, acier inoxydable / verre, clair

L 170, H 260, A 100

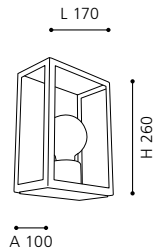
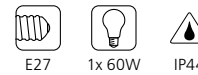

GL3390, GL3391

94787 ALAMONTE



table luminaire; stainless steel, stainless steel / glass, clear
Tischleuchte; Edelstahl, edelstahl / Glas, klar
luminaire de table; acier inoxydable, acier inoxydable / verre, clair

L 150, B 150, H 275

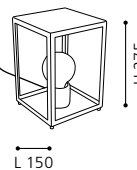
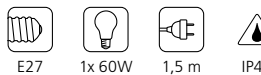

GL3394

94828 ALAMONTE



wall / ceiling luminaire; stainless steel, stainless steel / glass, clear
Wand- / Deckenleuchte; Edelstahl, edelstahl / Glas, klar
applique / plafonnier; acier inoxydable, acier inoxydable / verre, clair

L 290, H 290, A 130

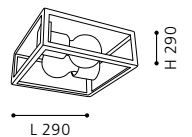

GL3392, GL3393



94833 ALAMONTE 1



GL3394

floor luminaire; galvanized steel, black / glass, clear
Stehleuchte; Stahl verzinkt, schwarz / Glas, klar
lampadaire; acier galvanisé, noir / verre, clair

94788 ALAMONTE 1



GL3394

GL3395



pendant luminaire; galvanized steel, black / glass, clear
Hängeleuchte; Stahl verzinkt, schwarz / Glas, klar
luminaire suspension; acier galvanisé, noir / verre, clair

L 150, B 150, H 1285

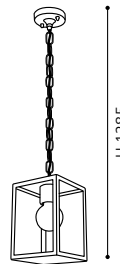

GL3394, GL3395

94831 ALAMONTE 1



GL3390

GL3391



wall luminaire; galvanized steel, black / glass, clear
Wandleuchte; Stahl verzinkt, schwarz / Glas, klar
applique; acier galvanisé, noir / verre, clair

L 170, H 260, A 100

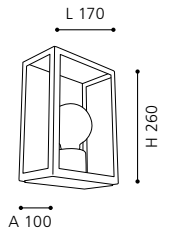

GL3390, GL3391

94789 ALAMONTE 1



GL3394



table luminaire; galvanized steel, black / glass, clear
Tischleuchte; Stahl verzinkt, schwarz / Glas, klar
luminaire de table; acier galvanisé, noir / verre, clair

L 150, B 150, H 275

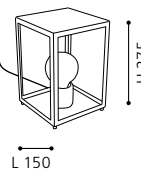

GL3394

94832 ALAMONTE 1



GL3393

GL3392



wall / ceiling luminaire; galvanized steel, black / glass, clear
Wand-/Deckenleuchte; Stahl verzinkt, schwarz / Glas, klar
applique / plafonnier; acier galvanisé, noir / verre, clair

L 290, H 290, A 130

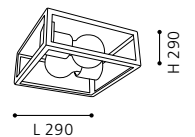

GL3392, GL3393

L 150, B 150, H 1015, Base: Ø 110

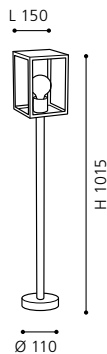

GL3394



94837 COLINDRES

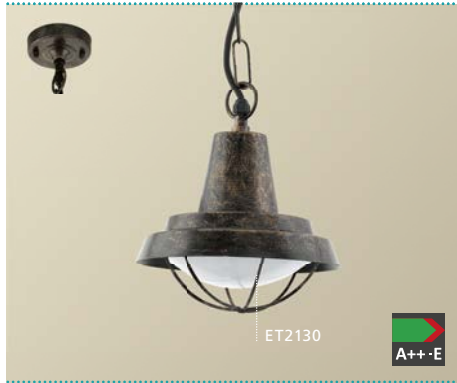

pendant luminaire; galvanized steel, copper-antique / plastic, white
 Hängeleuchte; Stahl verzinkt, kupferfarben-antik / Kunststoff, weiss
 luminaire suspension; acier galvanisé, cuivré / plastique, blanc

H 1270, Ø 215

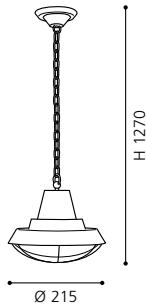
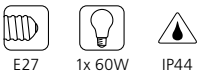

ET2130

94838 COLINDRES



wall luminaire; galvanized steel, copper-antique / plastic, white
 Wandleuchte; Stahl verzinkt, kupferfarben-antik / Kunststoff, weiss
 applique; acier galvanisé, cuivré / plastique, blanc

L 215, H 290, A 275

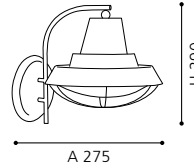

ET2130

94858 BARROSELA



wall luminaire; galvanized steel, copper-antique / plastic, white
 Wandleuchte; Stahl verzinkt, kupferfarben-antik / Kunststoff, weiss
 applique; acier galvanisé, cuivré / plastique, blanc

L 220, H 240, A 230

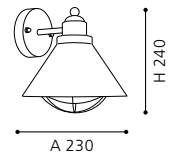

94863 MELGOA



wall luminaire; galvanized steel, copper-antique / glass, clear
 Wandleuchte; Stahl verzinkt, kupferfarben-antik / Glas, klar
 applique; acier galvanisé, cuivré / verre, clair

L 300, H 250, A 380

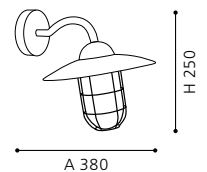

GL3396



94805 BARROSELA



wall luminaire; galvanized steel, black / plastic, white
 Wandleuchte; Stahl verzinkt, schwarz / Kunststoff, weiss
 applique; acier galvanisé, noir / plastique, blanc

L 220, H 240, A 230

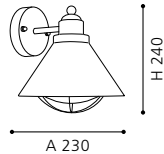

94861 COLINDRES 1



pendant luminaire; galvanized steel, black / plastic, white
 Hängeleuchte; Stahl verzinkt, schwarz / Kunststoff, weiss
 luminaire suspension; acier galvanisé, noir / plastique, blanc

H 1270, Ø 215

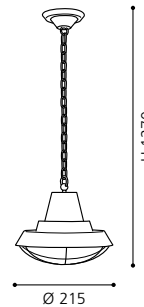

ET2130

94862 COLINDRES 1



wall luminaire; galvanized steel, black / plastic, white
 Wandleuchte; Stahl verzinkt, schwarz / Kunststoff, weiss
 applique; acier galvanisé, noir / plastique, blanc

L 215, H 290, A 275

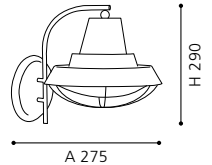

ET2130

94792 MELGOA



wall luminaire; galvanized steel, black / glass, clear
 Wandleuchte; Stahl verzinkt, schwarz / Glas, klar
 applique; acier galvanisé, noir / verre, clair

L 300, H 250, A 380

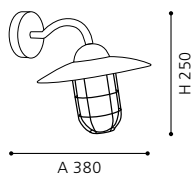

GL3396



94868 HILBURN 1



floor luminaire; galvanized steel, antique silver / plastic, transparent
Stehleuchte; Stahl verzinkt, silber-antik / Kunststoff, transparent
lampadaire; acier galvanisé, argent antique / plastique, transparent

L 200, B 135, H 1030

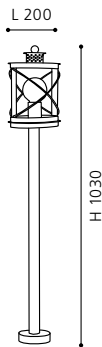

94865 HILBURN 1

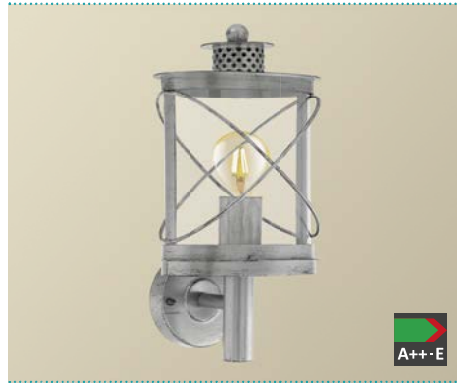

wall luminaire; galvanized steel, antique silver / plastic, transparent
Wandleuchte; Stahl verzinkt, silber-antik / Kunststoff, transparent
applique; acier galvanisé, argent antique / plastique, transparent

L 200, H 170, A 170

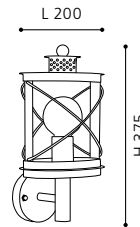

94866 HILBURN 1



wall luminaire; galvanized steel, antique silver / plastic, transparent
Wandleuchte; Stahl verzinkt, silber-antik / Kunststoff, transparent
applique; acier galvanisé, argent antique / plastique, transparent

L 200, H 280, A 200

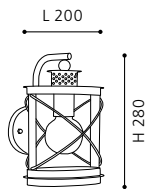

94867 HILBURN 1



pedestal luminaire; galvanized steel, antique silver / plastic, transparent
Sockelleuchte; Stahl verzinkt, silber-antik / Kunststoff, transparent
borne; acier galvanisé, argent antique / plastique, transparent

L 200, B 135, H 410

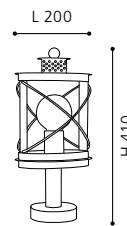

94859 BARROSELA



wall luminaire; galvanized steel, antique silver / plastic, white
Wandleuchte; Stahl verzinkt, silber-antik / Kunststoff, weiss
applique; acier galvanisé, argent antique / plastique, blanc

L 220, H 240, A 230

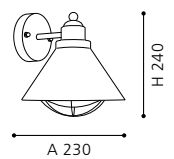
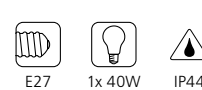



94844 HILBURN



floor luminaire; galvanized steel, black / plastic, transparent
Stehleuchte; Stahl verzinkt, schwarz / Kunststoff, transparent
lampadaire; acier galvanisé, noir / plastique, transparent

L 200, B 135, H 1030

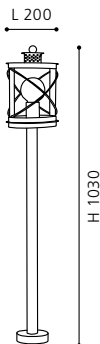
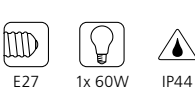

94842 HILBURN



wall luminaire; galvanized steel, black / plastic, transparent
Wandleuchte; Stahl verzinkt, schwarz / Kunststoff, transparent
applique; acier galvanisé, noir / plastique, transparent

L 200, H 375, A 170

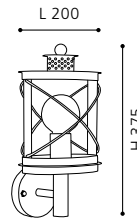
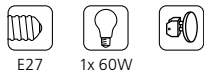

94843 HILBURN



wall luminaire; galvanized steel, black / plastic, transparent
Wandleuchte; Stahl verzinkt, schwarz / Kunststoff, transparent
applique; acier galvanisé, noir / plastique, transparent

L 200, H 280, A 200

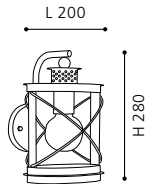

94864 HILBURN



pedestal luminaire; galvanized steel, black / plastic, transparent
Sockelleuchte; Stahl verzinkt, schwarz / Kunststoff, transparent
borne; acier galvanisé, noir / plastique, transparent

L 200, B 135, H 410

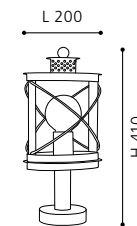



94836 PULFERO



floor luminaire; galvanized steel, black / plastic, transparent
Stehleuchte; Stahl verzinkt, schwarz / Kunststoff, transparent
lampadaire; acier galvanisé, noir / plastique, transparent

H 1020, Ø 220, Base: Ø 110



ET2131

94834 PULFERO



wall luminaire; galvanized steel, black / plastic, transparent
Wandleuchte; Stahl verzinkt, schwarz / Kunststoff, transparent
applique; acier galvanisé, noir / plastique, transparent

L 220, H 280, A 280

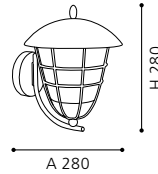

ET2131

94841 PULFERO



wall luminaire; galvanized steel, black / plastic, transparent
Wandleuchte; Stahl verzinkt, schwarz / Kunststoff, transparent
applique; acier galvanisé, noir / plastique, transparent

L 220, H 280, A 280

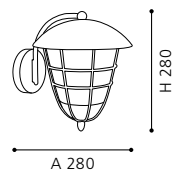
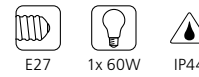

ET2131

94835 PULFERO



pedestal luminaire; galvanized steel, black / plastic, transparent
Sockelleuchte; Stahl verzinkt, schwarz / Kunststoff, transparent
borne; acier galvanisé, noir / plastique, transparent

H 415, Ø 220, Base: Ø 110

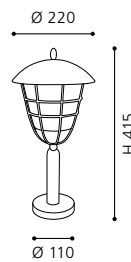

ET2131



94857 PULFERO 1



floor luminaire; galvanized steel, brown / plastic, transparent
Stehleuchte; Stahl verzinkt, braun / Kunststoff, transparent
lampadaire; acier galvanisé, marron / plastique, transparent

H 1020, Ø 220, Base: Ø 110



ET2131

94854 PULFERO 1



wall luminaire; galvanized steel, brown / plastic, transparent
Wandleuchte; Stahl verzinkt, braun / Kunststoff, transparent
applique; acier galvanisé, marron / plastique, transparent

L 220, H 280, A 280

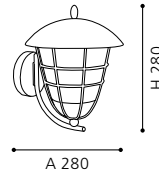

ET2131

94855 PULFERO 1



wall luminaire; galvanized steel, brown / plastic, transparent
Wandleuchte; Stahl verzinkt, braun / Kunststoff, transparent
applique; acier galvanisé, marron / plastique, transparent

L 220, H 280, A 280

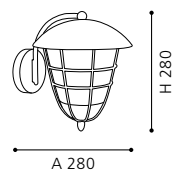
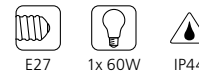

ET2131

94856 PULFERO 1



pedestal luminaire; galvanized steel, brown / plastic, transparent
Sockelleuchte; Stahl verzinkt, braun / Kunststoff, transparent
borne; acier galvanisé, marron / plastique, transparent

H 415, Ø 220, Base: Ø 110

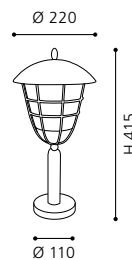

ET2131



93409 ALORIA



floor luminaire; cast aluminium, black / plastic, clear
 Stehleuchte; Aluguss, schwarz / Kunststoff, klar
 lampadaire; aluminium moulé, noir / plastique, clair

93408 ALORIA



floor luminaire; cast aluminium, black / plastic, clear
 Stehleuchte; Aluguss, schwarz / Kunststoff, klar
 lampadaire; aluminium moulé, noir / plastique, clair

93406 ALORIA



pendant luminaire; cast aluminium, black / plastic, clear
 Hängeleuchte; Aluguss, schwarz / Kunststoff, klar
 luminaire suspension; aluminium moulé, noir / plastique, clair

L 170, B 170, H 685

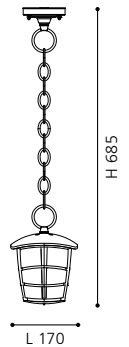
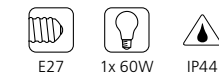

ET1572

93099 ALORIA



pedestal luminaire; cast aluminium, black / plastic, clear
 Sockelleuchte; Aluguss, schwarz / Kunststoff, klar
 borne; aluminium moulé, noir / plastique, clair

H 1800, Ø 480, Base: Ø 215

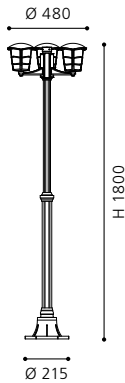

ET1572

L 170, B 170, H 940, Base: Ø 170



ET1572

L 170, B 170, H 300, Base: Ø 170

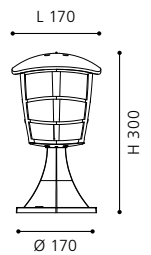
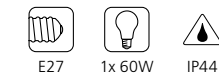

ET1572

93097 ALORIA



wall luminaire; cast aluminium, black / plastic, clear
 Wandleuchte; Aluguss, schwarz / Kunststoff, klar
 applique; aluminium moulé, noir / plastique, clair

L 170, H 225, A 190

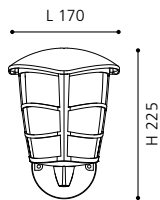

ET1572

93098 ALORIA



wall luminaire; cast aluminium, black / plastic, clear
 Wandleuchte; Aluguss, schwarz / Kunststoff, klar
 applique; aluminium moulé, noir / plastique, clair

L 170, H 225, A 190

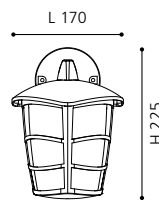

ET1572

93407 ALORIA



wall luminaire; cast aluminium, black / plastic, clear
 Wandleuchte; Aluguss, schwarz / Kunststoff, klar
 applique; aluminium moulé, noir / plastique, clair

L 180, H 200, A 120

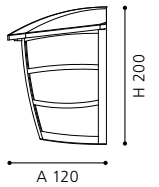

ET1573



93405 ALORIA



floor luminaire; cast aluminium, white / plastic, clear
 Stehleuchte; Aluguss, weiss / Kunststoff, klar
 lampadaire; aluminium moulé, blanc / plastique, clair

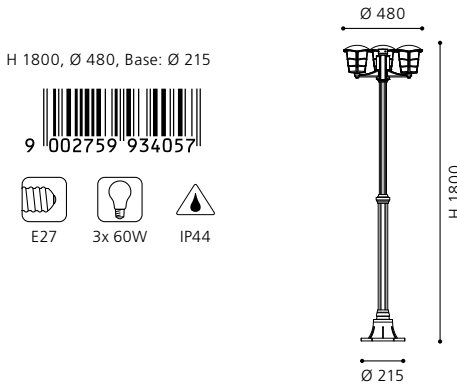

ET1572

93404 ALORIA



floor luminaire; cast aluminium, white / plastic, clear
 Stehleuchte; Aluguss, weiss / Kunststoff, klar
 lampadaire; aluminium moulé, blanc / plastique, clair

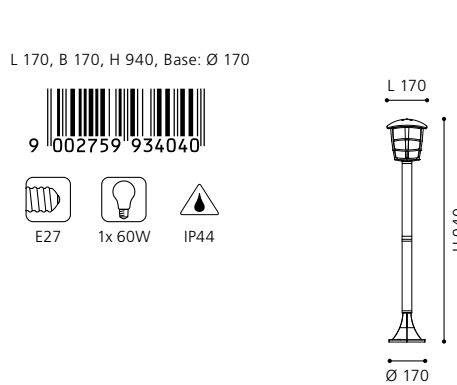

ET1572

93402 ALORIA



pendant luminaire; cast aluminium, white / plastic, clear
 Hängeleuchte; Aluguss, weiss / Kunststoff, klar
 luminaire suspension; aluminium moulé, blanc / plastique, clair

L 170, B 170, H 685

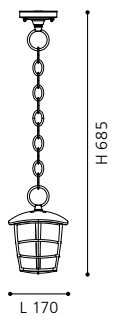
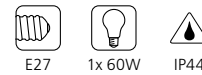

ET1572

93096 ALORIA



pedestal luminaire; cast aluminium, white / plastic, clear
 Sockelleuchte; Aluguss, weiss / Kunststoff, klar
 borne; aluminium moulé, blanc / plastique, clair

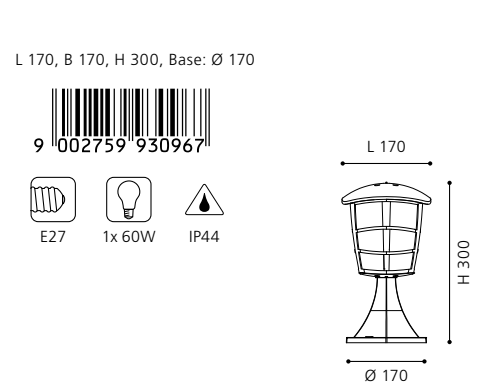

ET1572

93094 ALORIA



wall luminaire; cast aluminium, white / plastic, clear
 Wandleuchte; Aluguss, weiss / Kunststoff, klar
 applique; aluminium moulé, blanc / plastique, clair

L 170, H 225, A 190

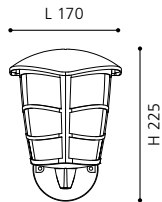

ET1572

93095 ALORIA



wall luminaire; cast aluminium, white / plastic, clear
 Wandleuchte; Aluguss, weiss / Kunststoff, klar
 applique; aluminium moulé, blanc / plastique, clair

L 170, H 225, A 190

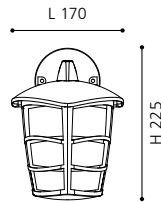

ET1572

93403 ALORIA



wall luminaire; cast aluminium, white / plastic, clear
 Wandleuchte; Aluguss, weiss / Kunststoff, klar
 applique; aluminium moulé, blanc / plastique, clair

L 180, H 200, A 120

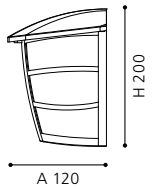

ET1573



93512 ALORIA-LED



wall luminaire; cast aluminium, white / plastic, white
Wandleuchte; Aluguss, weiss / Kunststoff, weiss
applique; aluminium moulé, blanc / plastique, blanc

L 170, H 225, A 190



- GX53
- 1x 7W
- 1x 550 lm
- IP44

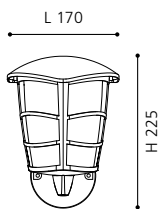

ET1574

93513 ALORIA-LED



wall luminaire; cast aluminium, white / plastic, white
Wandleuchte; Aluguss, weiss / Kunststoff, weiss
applique; aluminium moulé, blanc / plastique, blanc

L 170, H 225, A 190



- GX53
- 1x 7W
- 1x 550 lm
- IP44

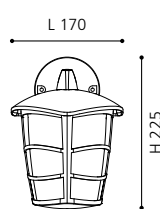

ET1574

93514 ALORIA-LED



wall luminaire; cast aluminium, white / plastic, white
Wandleuchte; Aluguss, weiss / Kunststoff, weiss
applique; aluminium moulé, blanc / plastique, blanc

L 180, H 200, A 120



- GX53
- 1x 7W
- 1x 550 lm
- IP44

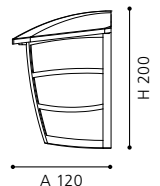

ET1575

93515 ALORIA-LED



wall luminaire; cast aluminium, black / plastic, white
Wandleuchte; Aluguss, schwarz / Kunststoff, weiss
applique; aluminium moulé, noir / plastique, blanc

L 170, H 225, A 190



- GX53
- 1x 7W
- 1x 550 lm
- IP44

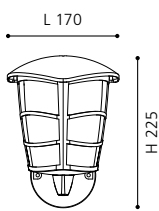

ET1574

93516 ALORIA-LED



wall luminaire; cast aluminium, black / plastic, white
Wandleuchte; Aluguss, schwarz / Kunststoff, weiss
applique; aluminium moulé, noir / plastique, blanc

L 170, H 225, A 190



- GX53
- 1x 7W
- 1x 550 lm
- IP44

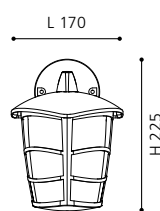

ET1574

93517 ALORIA-LED



wall luminaire; cast aluminium, black / plastic, white
Wandleuchte; Aluguss, schwarz / Kunststoff, weiss
applique; aluminium moulé, noir / plastique, blanc

L 180, H 200, A 120



- GX53
- 1x 7W
- 1x 550 lm
- IP44

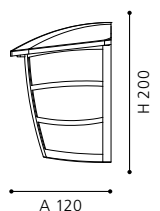

ET1575

LED



LED

94218 PATERNO



floor luminaire; cast aluminium, black / plastic, clear, white
 Stehleuchte; Aluguss, schwarz / Kunststoff, klar, weiss
 lampadaire; aluminium moulé, noir / plastique, clair, blanc

94217 PATERNO



floor luminaire; cast aluminium, black / plastic, clear, white
 Stehleuchte; Aluguss, schwarz / Kunststoff, klar, weiss
 lampadaire; aluminium moulé, noir / plastique, clair, blanc

94215 PATERNO



wall luminaire; cast aluminium, black / plastic, clear, white
 Wandleuchte; Aluguss, schwarz / Kunststoff, klar, weiss
 applique; aluminium moulé, noir / plastique, clair, blanc

L 190, H 230, A 241

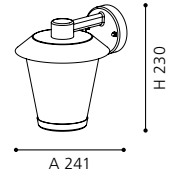

ET1834, ET1835

94216 PATERNO



floor luminaire; cast aluminium, black / plastic, clear, white
 Stehleuchte; Aluguss, schwarz / Kunststoff, klar, weiss
 lampadaire; aluminium moulé, noir / plastique, clair, blanc

L 465, B 425, H 1910

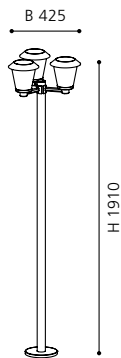
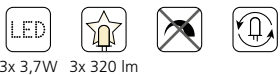

ET1834, ET1835

H 940, Ø 190

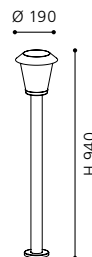

ET1834, ET1835

H 300, Ø 190

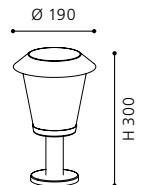

ET1834, ET1835

LED

94214 PATERNO



wall luminaire; cast aluminium, black / plastic, clear, white
 Wandleuchte; Aluguss, schwarz / Kunststoff, klar, weiss
 applique; aluminium moulé, noir / plastique, clair, blanc

L 190, H 230, A 241

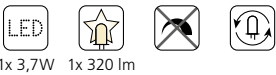

1x 3,7W 1x 320 lm



IP44

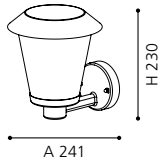

ET1834, ET1835



30186 LISIO



pendant luminaire; stainless steel, stainless steel / glass, clear
 Hängeleuchte; Edelstahl, edelstahl / Glas, klar
 luminaire suspension; acier inoxydable, acier inoxydable / verre, clair

30188 LISIO



floor luminaire; stainless steel, stainless steel / glass, clear
 Stehleuchte; Edelstahl, edelstahl / Glas, klar
 lampadaire; acier inoxydable, acier inoxydable / verre, clair

30184 LISIO

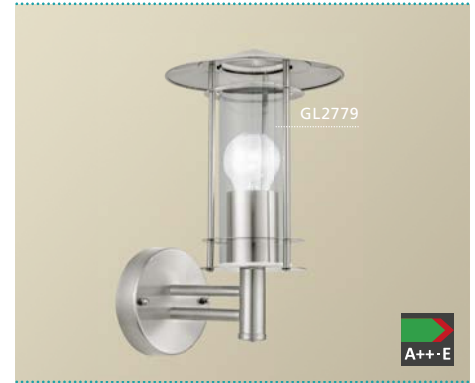

wall luminaire; stainless steel, stainless steel / glass, clear
 Wandleuchte; Edelstahl, edelstahl / Glas, klar
 applique; acier inoxydable, acier inoxydable / verre, clair

L 175, H 300, A 225



9 002759 301842



E27



1x 60W



IP44

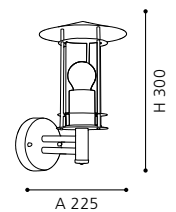

GL2779

30187 LISIO



floor luminaire; stainless steel, stainless steel / glass, clear
 Stehleuchte; Edelstahl, edelstahl / Glas, klar
 lampadaire; acier inoxydable, acier inoxydable / verre, clair

H 880, Ø 175



9 002759 301866



E27



1x 60W



IP44



GL2779

H 1000, Ø 175, Base: Ø 130



9 002759 301880



E27



1x 60W



IP44

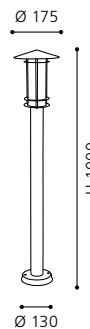

GL2779

H 500, Ø 175, Base: Ø 130



9 002759 301873



E27



1x 60W



IP44

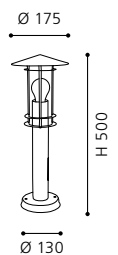

GL2779

30185 LISIO



wall luminaire; stainless steel, stainless steel / glass, clear
Wandleuchte; Edelstahl, edelstahl / Glas, klar
applique; acier inoxydable, acier inoxydable / verre, clair

L 175, H 360, A 225

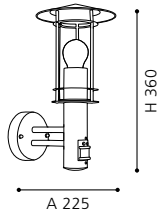

GL2779

80761 EXIT 1



wall luminaire; cast aluminium, silver
Wandleuchte; Aluguss, silber
applique; aluminium moulé, argent

L 230, H 285, A 130

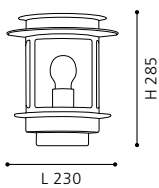

88711 SIDNEY

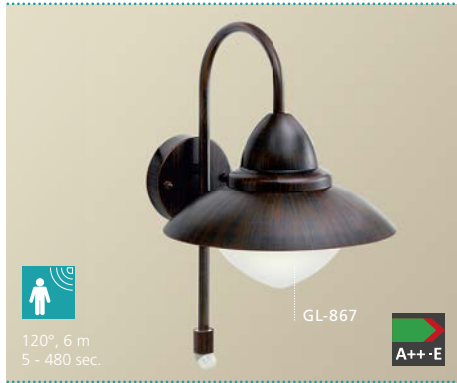

120°, 6 m
5 - 480 sec.

GL-867



wall luminaire; galvanized steel, antique brown /
satinated glass, white
**Wandleuchte; Stahl verzinkt, antik-braun /
Glas satiniert, weiss**
applique; acier galvanisé, marron antique /
verre satiné, blanc

H 375, Ø 275, A 325



9 002759 887117

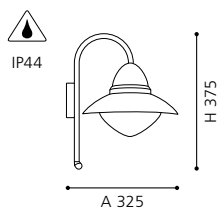

GL-867

87105 SIDNEY



120°, 6 m
5 - 480 sec.

GL-867



wall luminaire; stainless steel, stainless steel /
satinated glass, white
**Wandleuchte; Edelstahl, edelstahl /
Glas satiniert, weiss**
applique; acier inoxydable, acier inoxydable /
verre satiné, blanc

H 375, Ø 275, A 325



9 002759 871055

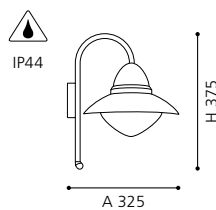

GL-867

88709 SIDNEY



120°, 6 m
5 - 480 sec.

GL-867



wall luminaire; galvanized steel, antique brown /
satinated glass, white
**Wandleuchte; Stahl verzinkt, antik-braun /
Glas satiniert, weiss**
applique; acier galvanisé, marron antique /
verre satiné, blanc

H 375, Ø 275, A 325



9 002759 887094

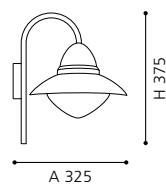

GL-867

83966 SIDNEY



120°, 6 m
5 - 480 sec.

GL-867



wall luminaire; stainless steel, stainless steel /
satinated glass, white
**Wandleuchte; Edelstahl, edelstahl /
Glas satiniert, weiss**
applique; acier inoxydable, acier inoxydable /
verre satiné, blanc

H 375, Ø 270, A 325



9 002759 839666

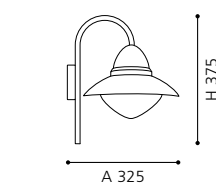

GL-867

83971 SIDNEY

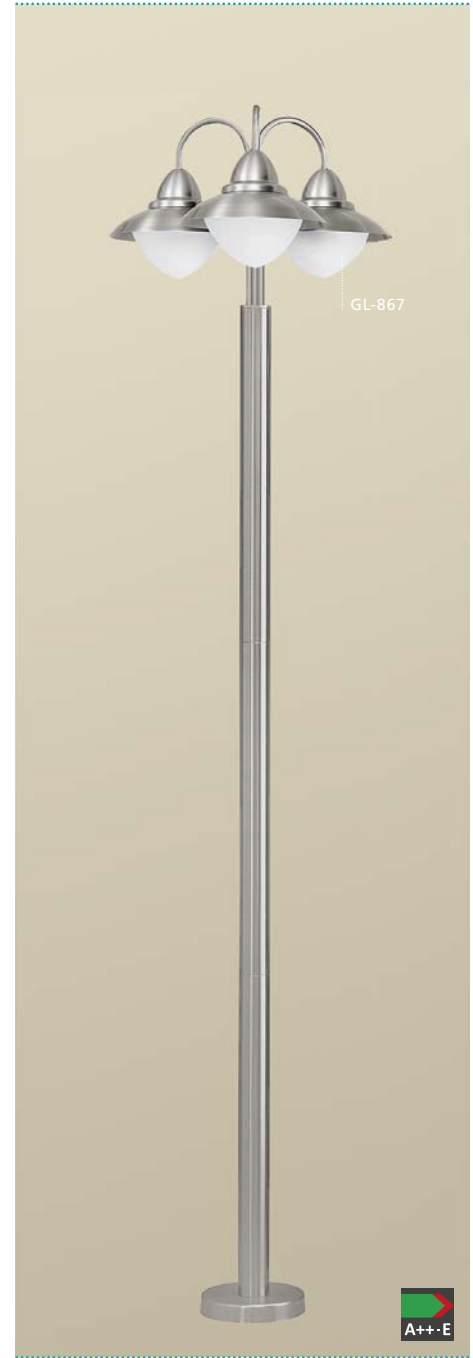

GL-867



floor luminaire; stainless steel, stainless steel /
satinated glass, white
**Stehleuchte; Edelstahl, edelstahl /
Glas satiniert, weiss**
lampadaire; acier inoxydable, acier inoxydable /
verre satiné, blanc

H 2200, Ø 600, Base: Ø 200



9 002759 839710

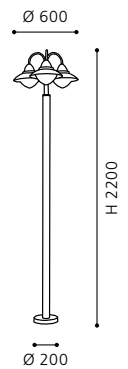

GL-867

83969 SIDNEY



floor luminaire; stainless steel, stainless steel /
satinated glass, white
Stehleuchte; Edelstahl, edelstahl /
Glas satiniert, weiss
lampadaire; acier inoxydable, acier inoxydable /
verre satiné, blanc

B 350, H 1200, Base: Ø 120



9 002759 839697



E27



1x 60W



IP44

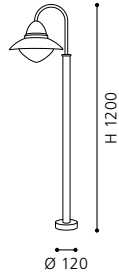

GL-867

83968 SIDNEY



pedestal luminaire; stainless steel, stainless steel /
satinated glass, white
Sockelleuchte; Edelstahl, edelstahl /
Glas satiniert, weiss
borne; acier inoxydable, acier inoxydable /
verre satiné, blanc

B 350, H 620, Base: Ø 120



9 002759 839680



E27



1x 60W



IP44

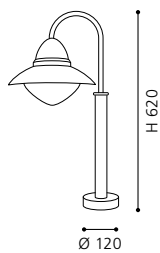

GL-867



93992 BUCKINGHAM



GL2308



wall luminaire; galvanized steel, black, patina silver /
waved glass, clear
Wandleuchte; Stahl verzinkt, schwarz, silber-patina /
Glas gewellt, klar
applique; acier galvanisé, noir, argent patiné /
verre ondulé, clair

L 105, H 380, A 160



9 002759 939922

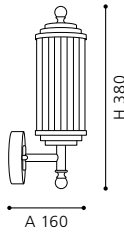

GL2308

94807 NABILA 1



wall luminaire; galvanized steel, antique brown / glass, clear
Wandleuchte; Stahl verzinkt, antik-braun / Glas, klar
applique; acier galvanisé, marron antique / verre, clair

L 110, H 385, A 155



9 002759 948078

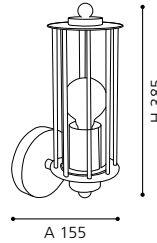

91121 RAIANO



ET0709



wall luminaire; galvanized steel, antique brown /
plastic, white
Wandleuchte; Stahl verzinkt, antik-braun /
Kunststoff, weiss
applique; acier galvanisé, marron antique /
plastique, blanc

L 125, H 350, A 170



9 002759 911218

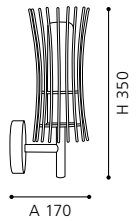
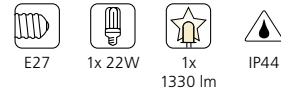

ET0709



89536 MINORCA



GL2095



floor luminaire; galvanized steel, coppery /
opal glass, shiny white
Stehleuchte; Stahl verzinkt, kupferfarben /
Glas opal, weiss glänzend
lampadaire; acier galvanisé, cuivré /
verre opale, blanc brillant

H 785, Ø 137, Base: Ø 100



9 002759 895365

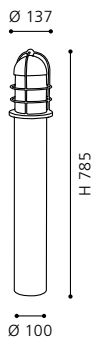

GL2095

89535 MINORCA



GL2095



pedestal luminaire; galvanized steel, coppery /
opal glass, shiny white
Sockelleuchte; Stahl verzinkt, kupferfarben /
Glas opal, weiss glänzend
borne; acier galvanisé, cuivré /
verre opale, blanc brillant

H 385, Ø 137, Base: Ø 100



9 002759 895358



Ø 137

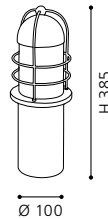

GL2095

89533 MINORCA



GL2095



wall luminaire; galvanized steel, coppery /
opal glass, shiny white
Wandleuchte; Stahl verzinkt, kupferfarben /
Glas opal, weiss glänzend
applique; acier galvanisé, cuivré /
verre opale, blanc brillant

B 137, H 365, A 185



9 002759 895334

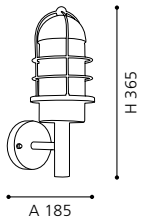

GL2095



83585 MILTON 1



wall luminaire; stainless steel, stainless steel / opal glass, white
 Wandleuchte; Edelstahl, edelstahl / Glas opal, weiss
 applique; acier inoxydable, acier inoxydable / verre opale, blanc

B 240, H 310, A 290

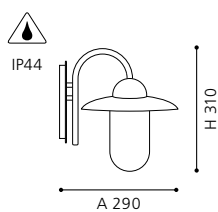

GL-849

83588 MILTON



wall luminaire; stainless steel, stainless steel / glass, clear
 Wandleuchte; Edelstahl, edelstahl / Glas, klar
 applique; acier inoxydable, acier inoxydable / verre, clair

B 240, H 310, A 300

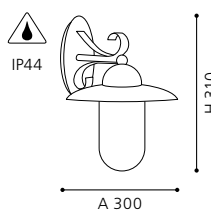
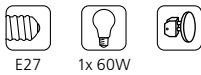

GL-859

83589 MILTON



wall luminaire; galvanized steel, antique brown / glass, clear
 Wandleuchte; Stahl verzinkt, antik-braun / Glas, klar
 applique; acier galvanisé, marron antique / verre, clair

B 240, H 310, A 300

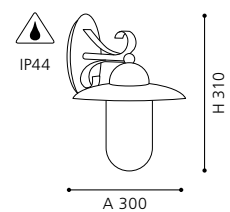
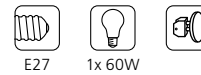

GL-859



3376 LATERNA 7



wall luminaire; cast aluminium, black / satinated glass, white
 Wandleuchte; Aluguss, schwarz / Glas satiniert, weiss
 applique; aluminium moulé, noir / verre satiné, blanc

L 155, H 220, A 170

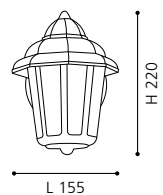

GL-059

90184 SAN TELMO



wall luminaire; galvanized steel, cast aluminium, antique brown / glass with blowholes, clear
Wandleuchte; Stahl verzinkt, Aluguss, antik-braun / Glas mit Lufteinschlüssen, klar
applique; marron antique / verre bullé, clair

L 180, H 350, A 240

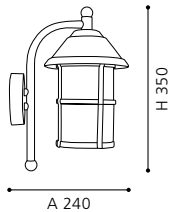

GL2534

88577 CITY CLASSIC



wall luminaire; stainless steel, black-gold / plastic, white
Wandleuchte; Edelstahl, schwarz-gold / Kunststoff, weiss
applique; acier inoxydable, noir-doré / plastique, blanc

L 235, H 260, A 90

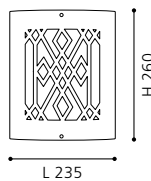

ET0234

5389 LATERNA 7



wall / ceiling luminaire; cast aluminium, black / satinated glass, white
Wand- / Deckenleuchte; Aluguss, schwarz / Glas satiniert, weiss
applique / plafonnier; aluminium moulé, noir / verre satiné, blanc

Ø 230, A 140

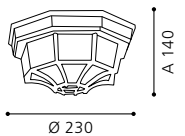

GL-058

90208 PORTICI



wall luminaire; stainless steel, stainless steel / opal glass, white
Wandleuchte; Edelstahl, edelstahl / Glas opal-matt, weiss
applique; acier inoxydable, acier inoxydable / verre opale, blanc

L 140, H 350, A 225

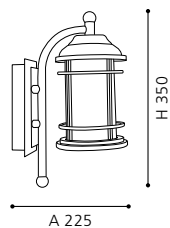

GL2351





93456 NAVEDO



wall luminaire; cast aluminium, black, patina silver / glass, clear
Wandleuchte; Aluguss, schwarz, silber-patina / Glas, klar
applique; aluminium moulé, noir, argent patiné / verre, clair

L 200, H 475, A 285

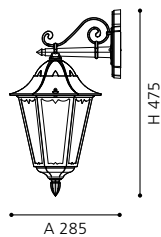

GL3005

93457 NAVEDO



wall luminaire; cast aluminium, black, patina silver / glass, clear
Wandleuchte; Aluguss, schwarz, silber-patina / Glas, klar
applique; aluminium moulé, noir, argent patiné / verre, clair

L 200, H 475, A 285

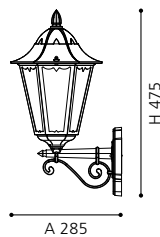

GL3005

93458 NAVEDO



wall luminaire; cast aluminium, black, patina silver / glass, clear
Wandleuchte; Aluguss, schwarz, silber-patina / Glas, klar
applique; aluminium moulé, noir, argent patiné / verre, clair

L 200, H 425, A 285

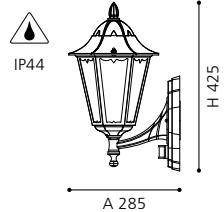

GL3005

93459 NAVEDO



wall luminaire; cast aluminium, black, patina silver / glass, clear
Wandleuchte; Aluguss, schwarz, silber-patina / Glas, klar
applique; aluminium moulé, noir, argent patiné / verre, clair

L 290, H 430, A 130

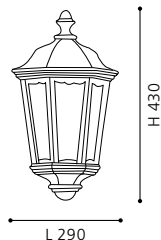
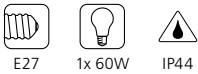

GL3006

93462 NAVEDO



pedestal luminaire; cast aluminium, black, patina silver / glass, clear
Sockelleuchte; Aluguss, schwarz, silber-patina / Glas, klar
borne; aluminium moulé, noir, argent patiné / verre, clair

H 470, Ø 230, Base: Ø 170

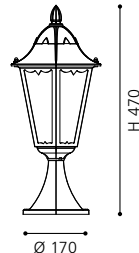

GL3005

93455 NAVEDO



pendant luminaire; cast aluminium, black, patina silver / glass, clear
Hängeleuchte; Aluguss, schwarz, silber-patina / Glas, klar
luminaire suspension; aluminium moulé, noir, argent patiné / verre, clair

H 1045, Ø 230

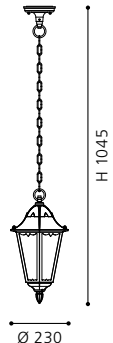

GL3005

93465 NAVEDO



floor luminaire; cast aluminium, black, patina silver /
glass, clear
Stehleuchte; Aluguss, schwarz, silber-patina /
Glas, klar
lampadaire; aluminium moulé, noir, argent patiné /
verre, clair

H 2200, Ø 560, Base: Ø 230

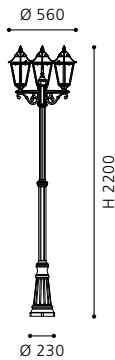

GL3005

93464 NAVEDO



floor luminaire; cast aluminium, black, patina silver /
glass, clear
Stehleuchte; Aluguss, schwarz, silber-patina /
Glas, klar
lampadaire; aluminium moulé, noir, argent patiné /
verre, clair

H 2000, Ø 230, Base: Ø 245

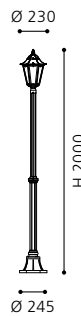

GL3005

93463 NAVEDO



floor luminaire; cast aluminium, black, patina silver /
glass, clear
Stehleuchte; Aluguss, schwarz, silber-patina /
Glas, klar
lampadaire; aluminium moulé, noir, argent patiné /
verre, clair

H 1200, Ø 230, Base: Ø 170

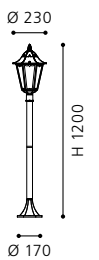

GL3005

93454 NAVEDO



floor luminaire; cast aluminium, white / glass, clear
 Stehleuchte; Aluguss, weiss / Glas, klar
 lampadaire; aluminium moulé, blanc / verre, clair

93453 NAVEDO



floor luminaire; cast aluminium, white / glass, clear
 Stehleuchte; Aluguss, weiss / Glas, klar
 lampadaire; aluminium moulé, blanc / verre, clair

93452 NAVEDO



floor luminaire; cast aluminium, white / glass, clear
 Stehleuchte; Aluguss, weiss / Glas, klar
 lampadaire; aluminium moulé, blanc / verre, clair

H 2200, Ø 560, Base: Ø 230



9 002759 934545



E27



3x 60W



IP44

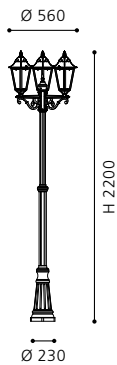

GL3005

H 2000, Ø 230, Base: Ø 245



9 002759 934538



E27



1x 60W



IP44



GL3005

H 1200, Ø 230, Base: Ø 170



9 002759 934521



E27



1x 60W



IP44

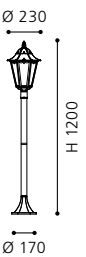

GL3005

93445 NAVEDO



wall luminaire; cast aluminium, white / glass, clear
Wandleuchte; Aluguss, weiss / Glas, klar
applique; aluminium moulé, blanc / verre, clair

L 200, H 475, A 285

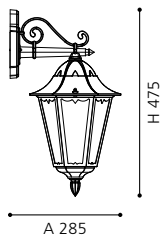
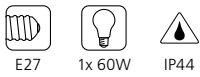

GL3005

93446 NAVEDO



wall luminaire; cast aluminium, white / glass, clear
Wandleuchte; Aluguss, weiss / Glas, klar
applique; aluminium moulé, blanc / verre, clair

L 200, H 475, A 285

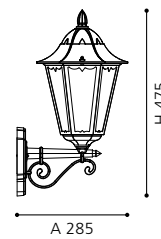

GL3005

93447 NAVEDO



wall luminaire; cast aluminium, white / glass, clear
Wandleuchte; Aluguss, weiss / Glas, klar
applique; aluminium moulé, blanc / verre, clair

L 200, H 425, A 285

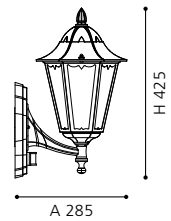

GL3005

93448 NAVEDO



wall luminaire; cast aluminium, white / glass, clear
Wandleuchte; Aluguss, weiss / Glas, klar
applique; aluminium moulé, blanc / verre, clair

L 290, H 430, A 130

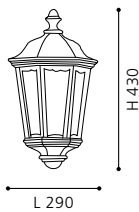

GL3006

93451 NAVEDO



pedestal luminaire; cast aluminium, white / glass, clear
Sockelleuchte; Aluguss, weiss / Glas, klar
borne; aluminium moulé, blanc / verre, clair

H 470, Ø 230, Base: Ø 170

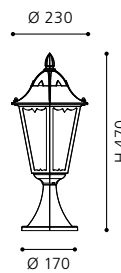

GL3005

93444 NAVEDO



pendant luminaire; cast aluminium, white / glass, clear
Hängeleuchte; Aluguss, weiss / Glas, klar
luminaire suspension; aluminium moulé, blanc / verre, clair

H 1045, Ø 230

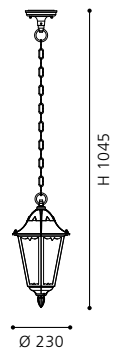

GL3005



22996 LATERNA 5



floor luminaire; cast aluminium, white / glass, clear
 Stehleuchte; Aluguss, weiss / Glas, klar
 lampadaire; aluminium moulé, blanc / verre, clair

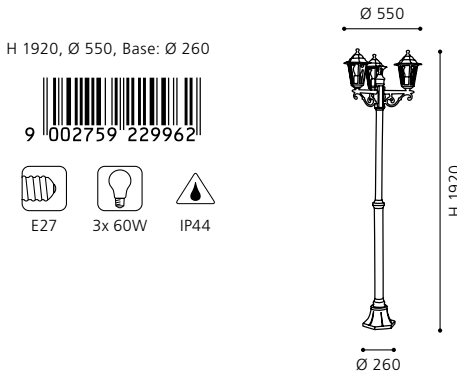

GL3007

22995 LATERNA 5



floor luminaire; cast aluminium, white / glass, clear
 Stehleuchte; Aluguss, weiss / Glas, klar
 lampadaire; aluminium moulé, blanc / verre, clair

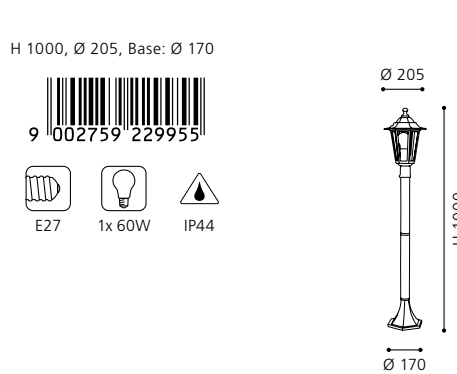

GL3007

22465 LATERNA 5



pendant luminaire; cast aluminium, white / glass, clear
 Hängeleuchte; Aluguss, weiss / Glas, klar
 luminaire suspension; aluminium moulé, blanc / verre, clair

H 900, Ø 205

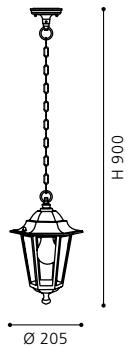

GL3007

22466 LATERNA 5



pedestal luminaire; cast aluminium, white / glass, clear
 Sockelleuchte; Aluguss, weiss / Glas, klar
 borne; aluminium moulé, blanc / verre, clair

H 405, Ø 205, Base: Ø 170

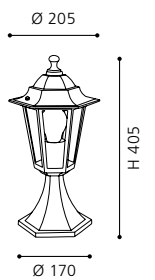

GL3007

22463 LATERNA 5



wall luminaire; cast aluminium, white / glass, clear
Wandleuchte; Aluguss, weiss / Glas, klar
applique; aluminium moulé, blanc / verre, clair

22462 LATERNA 5



wall luminaire; cast aluminium, white / glass, clear
Wandleuchte; Aluguss, weiss / Glas, klar
applique; aluminium moulé, blanc / verre, clair

22464 LATERNA 5



wall luminaire; cast aluminium, white / glass, clear
Wandleuchte; Aluguss, weiss / Glas, klar
applique; aluminium moulé, blanc / verre, clair

L 165, H 350, A 215

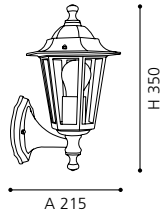

GL3007

L 165, H 350, A 215

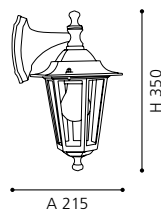

GL3007

L 165, H 425, A 235

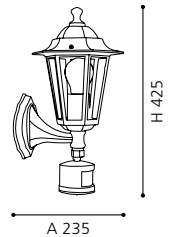

GL3007



22145 LATERNA 4



floor luminaire; cast aluminium, black / glass, clear
 Stehleuchte; Aluguss, schwarz / Glas, klar
 lampadaire; aluminium moulé, noir / verre, clair

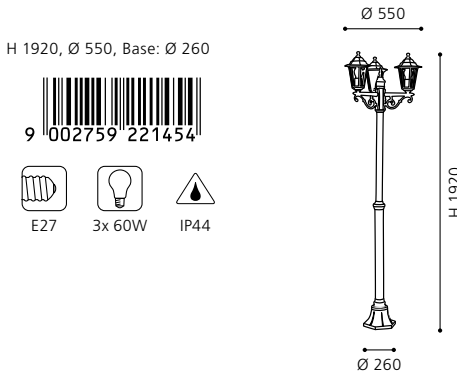

GL3007

22144 LATERNA 4



floor luminaire; cast aluminium, black / glass, clear
 Stehleuchte; Aluguss, schwarz / Glas, klar
 lampadaire; aluminium moulé, noir / verre, clair

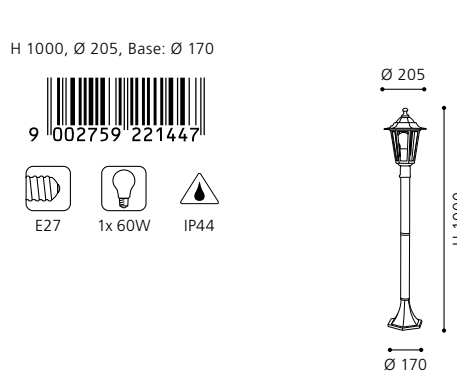

GL3007

22471 LATERNA 4



pendant luminaire; cast aluminium, black / glass, clear
 Hängeleuchte; Aluguss, schwarz / Glas, klar
 luminaire suspension; aluminium moulé, noir / verre, clair

H 900, Ø 205

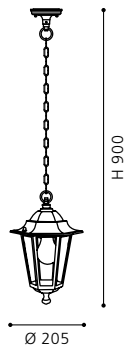

GL3007

22472 LATERNA 4



pedestal luminaire; cast aluminium, black / glass, clear
 Sockelleuchte; Aluguss, schwarz / Glas, klar
 borne; aluminium moulé, noir / verre, clair

L 205, B 165, H 405, Base: Ø 170

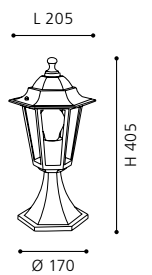

GL3007

22467 LATERNA 4



wall luminaire; cast aluminium, black / glass, clear
 Wandleuchte; Aluguss, schwarz / Glas, klar
 applique; aluminium moulé, noir / verre, clair

L 165, H 350, A 215

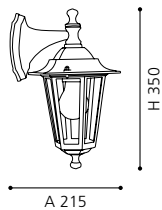
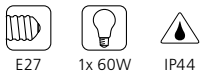

GL3007

22468 LATERNA 4



wall luminaire; cast aluminium, black / glass, clear
 Wandleuchte; Aluguss, schwarz / Glas, klar
 applique; aluminium moulé, noir / verre, clair

L 165, H 350, A 215

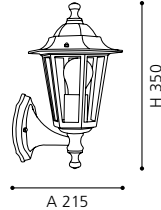

GL3007

22469 LATERNA 4



wall luminaire; cast aluminium, black / glass, clear
 Wandleuchte; Aluguss, schwarz / Glas, klar
 applique; aluminium moulé, noir / verre, clair

L 165, H 425, A 235

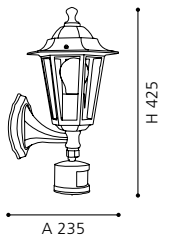
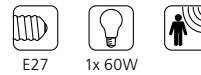

GL3007





4171 OUTDOOR CLASSIC



floor luminaire; cast aluminium, black-green / glass, clear
 Stehleuchte; Aluguss, schwarz-grün / Glas, klar
 lampadaire; aluminium moulé, noir-vert / verre, clair

H 2130, Ø 530, Base: Ø 250



E27



3x 60W



IP23

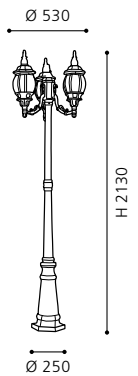

GL-857, GL-858

4172 OUTDOOR CLASSIC



floor luminaire; cast aluminium, black-green / glass, clear
 Stehleuchte; Aluguss, schwarz-grün / Glas, klar
 lampadaire; aluminium moulé, noir-vert / verre, clair

H 1200, Ø 190, Base: Ø 150

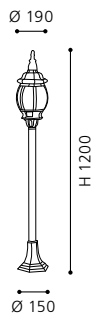

GL-857, GL-858

4174 OUTDOOR CLASSIC



wall luminaire; cast aluminium, black-green / glass, clear
 Wandleuchte; Aluguss, schwarz-grün / Glas, klar
 applique; aluminium moulé, noir-vert / verre, clair

B 190, H 530, A 260

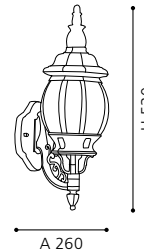

GL-857, GL-858

4175 OUTDOOR CLASSIC



wall luminaire; cast aluminium, black-green / glass, clear
 Wandleuchte; Aluguss, schwarz-grün / Glas, klar
 applique; aluminium moulé, noir-vert / verre, clair

B 190, H 480, A 260

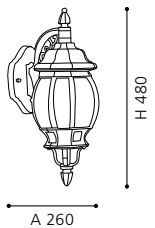

GL-857, GL-858

4173 OUTDOOR CLASSIC



pedestal luminaire; cast aluminium, black-green / glass, clear
 Sockelleuchte; Aluguss, schwarz-grün / Glas, klar
 borne; aluminium moulé, noir-vert / verre, clair

H 600, Ø 190, Base: Ø 150

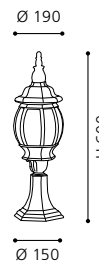

GL-857, GL-858



Spots / Recessed
& Accessories

Overview



RIGA 1
p. 111



NEMA 1
p. 111



NEMA 1
p. 111



NEMA
p. 111



STOCKHOLM 1
p. 111



FAEDO 1
p. 112



FAEDO 1
p. 112



FAEDO
p. 114



FAEDO
p. 114



FAEDO
p. 115



ALEGA
p. 115



GAVELLO
p. 115



ALEGA
p. 115



ZIMBA-LED
p. 116



ZIMBA-LED
p. 116



ZIMBA
p. 116



ZIMBA
p. 116



LAMEDO
p. 118



LAMEDO
p. 118



RIGA 3
p. 118



MARGO
p. 118



DETECT ME
p. 120



CUBA
p. 120



p. 120



PARK 4
p. 121



CONNECTOR BOX
p. 121

LED



94111

NEMA comes with 3 different coloured bulb shades.

NEMA wird mit 3 verschiedenen farbigen Leuchtmittelabdeckungen ausgeliefert.

NEMA vient avec 3 couvercles d'ampoule en couleurs différentes.

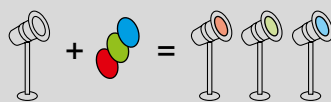

- GL2640
- GL2642
- GL2641
- GL2643

94109 RIGA 1



ground spike; stainless steel, stainless steel
Erdspieß; Edelstahl, edelstahl
acier inoxydable, acier inoxydable

B 140, H 630



9 002759 941093

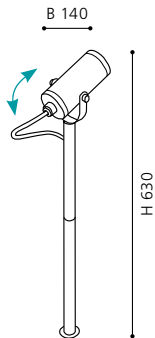

93384 NEMA 1



ground spike; plastic, black / plastic, transparent
Erdspieß; Kunststoff, schwarz / Kunststoff, transparent
plastique, noir / plastique, transparent

L 115, B 60, H 185



9 002759 933845

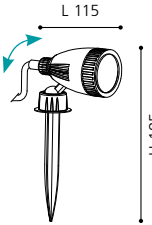

93385 NEMA 1



ground spike; plastic, black / plastic, transparent
Erdspieß; Kunststoff, schwarz / Kunststoff, transparent
plastique, noir / plastique, transparent

L 115, B 115, H 180



9 002759 933852

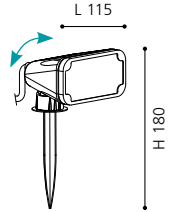

94111 NEMA



ground spike; stainless steel, stainless steel
Erdspieß; Edelstahl, edelstahl
acier inoxydable, acier inoxydable

L 110, B 85, H 240, ET 165



9 002759 941116

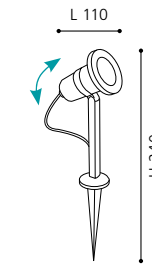

GL2640, GL2641, GL2642, GL2643

93268 STOCKHOLM 1



wall luminaire; stainless steel, stainless steel / glass, clear
Wandleuchte; Edelstahl, edelstahl / Glas, klar
applique; acier inoxydable, acier inoxydable / verre, clair

Ø 65



9 002759 932688

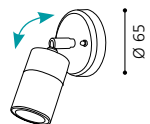

LED

95403 FAEDO 1



wall luminaire; aluminium, silver / glass, clear
Wandleuchte; Alu, silber / Glas, klar
applique; aluminium, argent / verre, clair

L 130, H 105, A 50

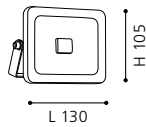

95404 FAEDO 1



wall luminaire; aluminium, silver / glass, clear
Wandleuchte; Alu, silber / Glas, klar
applique; aluminium, argent / verre, clair

L 160, H 140, A 50

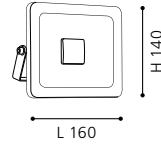

95405 FAEDO 1



wall luminaire; aluminium, silver / glass, clear
Wandleuchte; Alu, silber / Glas, klar
applique; aluminium, argent / verre, clair

L 205, H 155, A 50

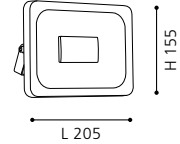

95407 FAEDO 1



wall luminaire; aluminium, silver / glass, clear
Wandleuchte; Alu, silber / Glas, klar
applique; aluminium, argent / verre, clair

L 130, H 190, A 50

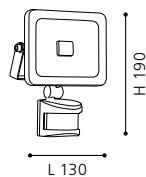
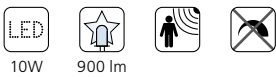

95408 FAEDO 1



wall luminaire; aluminium, silver / glass, clear
Wandleuchte; Alu, silber / Glas, klar
applique; aluminium, argent / verre, clair

L 160, H 220, A 50

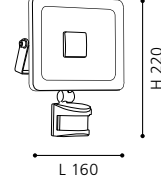
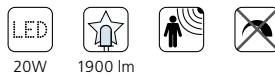

95409 FAEDO 1



wall luminaire; aluminium, silver / glass, clear
Wandleuchte; Alu, silber / Glas, klar
applique; aluminium, argent / verre, clair

L 205, H 235, A 50

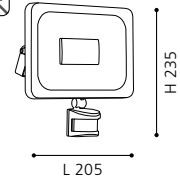

LED

95406 FAEDO 1



wall luminaire; aluminium, silver / glass, clear
 Wandleuchte; Alu, silber / Glas, klar
 applique; aluminium, argent / verre, clair

L 245, H 175, A 50

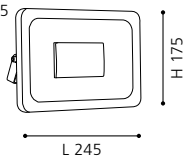

95411 FAEDO 1



wall luminaire; aluminium, silver / glass, clear
 Wandleuchte; Alu, silber / Glas, klar
 applique; aluminium, argent / verre, clair

L 245, H 250, A 50

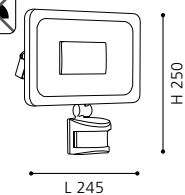

FAEDO 1

Luminaire with extraflat housing.

Leuchte mit extraflachen Gehäuse.

Luminaire avec boîtier extra plat.

93473 FAEDO



wall luminaire; aluminium, silver / glass, clear
Wandleuchte; Alu, silber / Glas, klar
applique; aluminium, argent / verre, clair

L 115, H 100, A 95

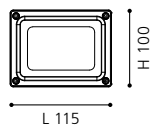
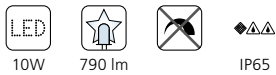

93474 FAEDO



wall luminaire; aluminium, silver / glass, clear
Wandleuchte; Alu, silber / Glas, klar
applique; aluminium, argent / verre, clair

L 180, H 155, A 100

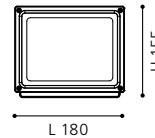

93475 FAEDO



wall luminaire; aluminium, silver / glass, clear
Wandleuchte; Alu, silber / Glas, klar
applique; aluminium, argent / verre, clair

L 225, H 250, A 105

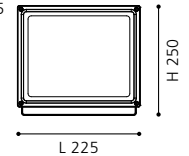

93476 FAEDO



wall luminaire; aluminium, silver / glass, clear
Wandleuchte; Alu, silber / Glas, klar
applique; aluminium, argent / verre, clair

L 115, H 150, A 110

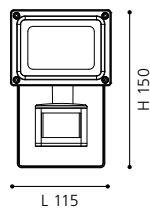
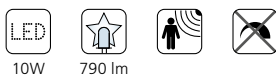

93477 FAEDO



wall luminaire; aluminium, silver / glass, clear
Wandleuchte; Alu, silber / Glas, klar
applique; aluminium, argent / verre, clair

L 180, H 155, A 100

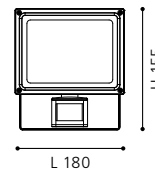
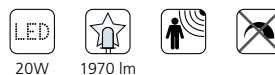

93478 FAEDO



wall luminaire; aluminium, silver / glass, clear
Wandleuchte; Alu, silber / Glas, klar
applique; aluminium, argent / verre, clair

L 225, H 250, A 105

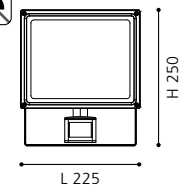
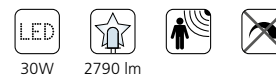

93479 FAEDO



floor luminaire; aluminium, yellow, black / glass, clear
 Stehleuchte; Alu, gelb, schwarz / Glas, klar
 lampadaire; aluminium, jaune, noir / verre, clair

L 225, B 100, H 280

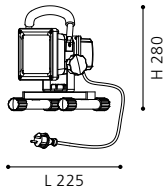
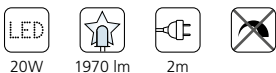

88812 ALEGA



wall luminaire; cast aluminium, black / glass, clear
 Wandleuchte; Aluguss, schwarz / Glas, klar
 applique; aluminium moulé, noir / verre, clair

L 185, H 170, A 140

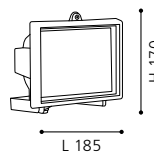

88814 ALEGA



wall luminaire; cast aluminium, black / glass, clear
 Wandleuchte; Aluguss, schwarz / Glas, klar
 applique; aluminium moulé, noir / verre, clair

L 140, H 130, A 95

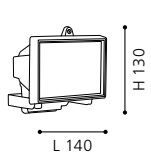
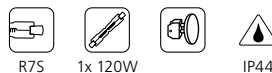

94399 GAVELLO



wall luminaire; plastic, white / plastic, transparent
 Wandleuchte; Kunststoff, weiss / Kunststoff, transparent
 applique; plastique, blanc / plastique, transparent

L 125, H 90, A 60



88813 ALEGA



wall luminaire; cast aluminium, black / glass, clear
 Wandleuchte; Aluguss, schwarz / Glas, klar
 applique; aluminium moulé, noir / verre, clair

L 185, H 265, A 155

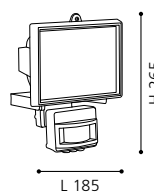

88815 ALEGA



wall luminaire; cast aluminium, black / glass, clear
 Wandleuchte; Aluguss, schwarz / Glas, klar
 applique; aluminium moulé, noir / verre, clair

L 140, H 180, A 145

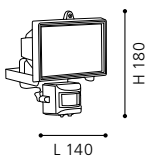

LED

95235 ZIMBA-LED



recessed luminaire; cast aluminium, silver
 Einbauleuchte; Aluguss, silber
 luminaire encastrable; aluminium moulé, argent

L 140, B 140, H 5, ET 95

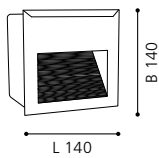

95234 ZIMBA-LED



recessed luminaire; cast aluminium, silver
 Einbauleuchte; Aluguss, silber
 luminaire encastrable; aluminium moulé, argent

L 235, B 185, H 5, ET 95

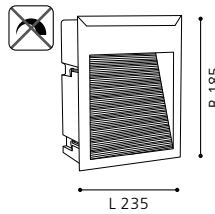

95233 ZIMBA-LED



recessed luminaire; cast aluminium, silver
 Einbauleuchte; Aluguss, silber
 luminaire encastrable; aluminium moulé, argent

H 5, Ø 125, ET 95

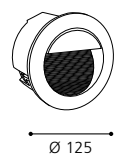

88008 ZIMBA



recessed luminaire; cast aluminium, silver
 Einbauleuchte; Aluguss, silber
 luminaire encastrable; aluminium moulé, argent

L 243, B 101, H 5, ET 100

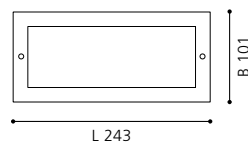

GL1605

88575 ZIMBA



recessed luminaire; cast aluminium, silver / satinated glass, white
 Einbauleuchte; Aluguss, silber / Glas satiniert, weiss
 luminaire encastrable; aluminium moulé, argent / verre satiné, blanc

L 227, B 127, H 13, ET 75

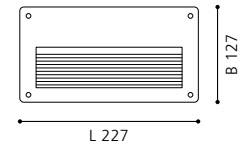
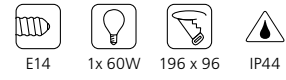

LED



LED

93481 LAMEDO



ground recessed luminaire; stainless steel, stainless steel / satinated glass, white
Bodeneinbauleuchte; Edelstahl, edelstahl / Glas satiniert, weiss
luminaire encastrable au; acier inoxydable, acier inoxydable / verre satiné, blanc

L 100, B 100, ET 65

9 002759 934811

LED, 1x 2,5W, 1x 180 lm, Ø 95, IP65/67

GL3084

93482 LAMEDO



ground recessed luminaire; stainless steel, stainless steel / satinated glass, white
Bodeneinbauleuchte; Edelstahl, edelstahl / Glas satiniert, weiss
luminaire encastrable au; acier inoxydable, acier inoxydable / verre satiné, blanc

Ø 100, ET 65

9 002759 934828

LED, 1x 2,5W, 1x 180 lm, Ø 95, IP65/67

GL3084

86189 RIGA 3



ground recessed luminaire; stainless steel, stainless steel / plastic, white
Bodeneinbauleuchte; Edelstahl, edelstahl / Kunststoff, weiss
luminaire encastrable au; acier inoxydable, acier inoxydable / plastique, blanc

H 285, Ø 170

9 002759 861896

E27, 1x 15W, IP67

ET0436, GL2438



IP20



IP65

94092, 94093

These luminaires are protected with IP65 on the frontside and IP20 on the backside.

Diese Leuchten sind mit IP65 frontseitig und IP20 rückseitig geschützt.

Disposent d'un degré de protection élevé IP65 en face avant et IP20 en face arrière pour l'utilisation.

94092 MARGO

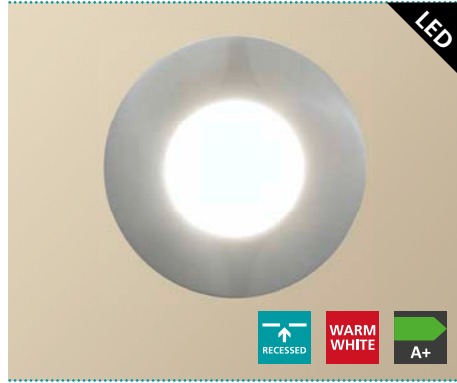

recessed luminaire; cast aluminium, stainless steel / satinated glass, white
Einbauleuchte; Aluguss, edelstahl / Glas satiniert, weiss
luminaire encastrable; aluminium moulé, acier inoxydable / verre satiné, blanc

H 10, Ø 84, ET 125

9 002759 940928

GU10, 1x 5W, 1x 350 lm, Ø 78, IP65/20

94093 MARGO

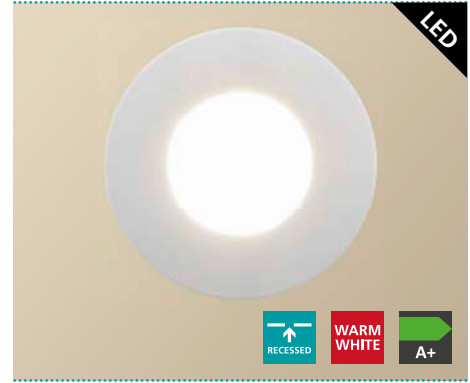

recessed luminaire; cast aluminium, white / satinated glass, white
Einbauleuchte; Aluguss, weiss / Glas satiniert, weiss
luminaire encastrable; aluminium moulé, blanc / verre satiné, blanc

H 10, Ø 84, ET 125

9 002759 940935

GU10, 1x 5W, 1x 350 lm, Ø 78, IP65/20

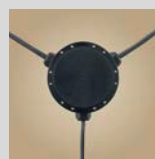

LAMEDO, RIGA 3 - p. 121

No more annoying cables in your garden: bury them simply and safely with the CONNECTOR BOX.

Mit der CONNECTOR BOX können Sie störende Kabel einfach und sicher unter der Erde verschwinden lassen.

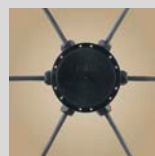

Tous les câbles incommodants disparaissent simplement et sûrement dans votre jardin avec CONNECTOR BOX.

30199 DETECT ME



180°, 10 m
5 - 240 sec.

accessory; plastic, black
Zubehör; Kunststoff, schwarz
accessoire; plastique, noir

30201 DETECT ME



180°, 10 m
5 - 240 sec.

accessory; plastic, white
Zubehör; Kunststoff, weiss
accessoire; plastique, blanc

88744 CUBA



ground spike; steel, hot-dip galvanised
Erdspieß; Stahl, feuerverzinkt
acier, galvanisé à chaud

L 62, H 82, A 92



9 002759 301996



IP44

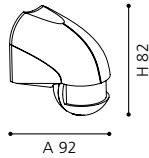

L 62, H 82, A 92



9 002759 302016



IP44

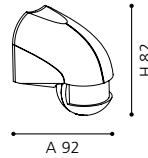

H 300, Ø 185



9 002759 887445



8x

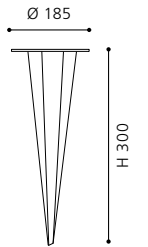

88153

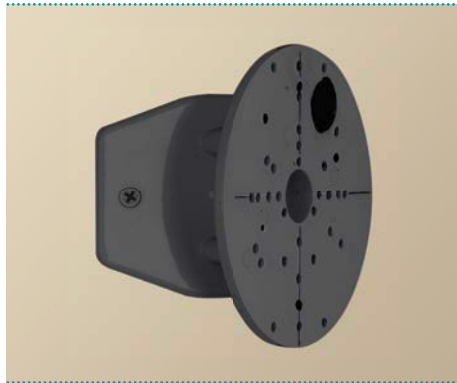

accessory; steel, black
Zubehör; Stahl, schwarz
accessoire; acier, noir

Ø 112



9 002759 881535

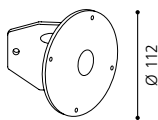

88152



accessory; steel, white
Zubehör; Stahl, weiss
accessoire; acier, blanc

Ø 112



9 002759 881528

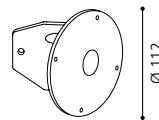

94112

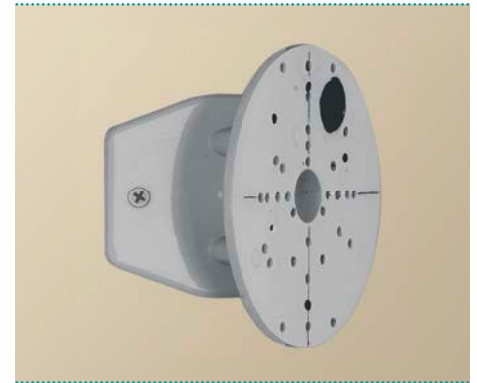

accessory; steel, silver
Zubehör; Stahl, silber
accessoire; acier, argent

Ø 112



9 002759 941123

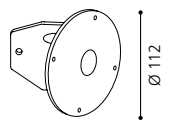



30199, 30201

The DETECT ME sensors are designed for max. 1000 watt when using incandescent lamps or max. 300 watt when using fluorescent lamps.

Die beiden DETECT ME Sensoren sind für max. 1000 Watt bei Glühlampen bzw. max. 300 Watt bei Energiesparlampen ausgelegt.

Les capteurs DETECT ME sont construits pour max 1000 watt lorsqu'il utilise un lampe à incandescence ou max 300 watt lorsqu'il utilise un lampe fluorescente.



88744

With the CUBA ground spike you can stick your floor luminaire in the ground or set it in concrete.

Mit dem CUBA Erdspeiß können Sie Ihre Stehleuchte in den Boden stecken oder einbetonieren.

Avec le piquet de terre CUBA vous pouvez fixer votre lampadaire en sol ou au béton.



88152, 88153, 94112

The above mentioned pictogram indicates suitable luminaires which can be easily mounted on corners with this accessories.

Das oben gezeigte Piktogramm markiert passende Leuchten, welche mit dem Zubehör einfach an Ecken montiert werden können.

Le pictogramme ci-dessus marque les luminaires correspondant, qui peut être monté avec les accessoires simples dans les coins.



No more annoying cables in your garden: bury them simply and safely with the CONNECTOR BOX.

91206: 1 supply line and 2 distribution lines
91207: 1 supply line and 5 distribution lines

Mit der CONNECTOR BOX können Sie störende Kabel einfach und sicher unter der Erde verschwinden lassen.

91206: 1 Zuleitung und 2 Verteilungsleitungen
91207: 1 Zuleitung und 5 Verteilungsleitungen

Tous les câbles incommodes disparaissent simplement et sûrement dans votre jardin avec CONNECTOR BOX.

91206: 1 alimentation et 2 lignes de distribution
91207: 1 alimentation et 5 lignes de distribution

90748 PARK 4



accessory; stainless steel, stainless steel / plastic, green
Zubehör; Edelstahl, edelstahl / Kunststoff, grün
accessoire; acier inoxydable, acier inoxydable / plastique, vert

L 115, B 115, H 400, Base: B 160, T 160



9 002759 907488



IP44

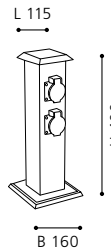

93426 PARK 4



accessory; steel, plastic, black
Zubehör; Stahl, Kunststoff, schwarz
accessoire; acier, plastique, noir

L 115, B 115, H 400, Base: B 160, T 160



9 002759 934262



IP44

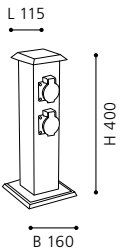

91206 CONNECTOR BOX



accessory; plastic, black
Zubehör; Kunststoff, schwarz
accessoire; plastique, noir

H 50, Ø 155



9 002759 912062



IP68

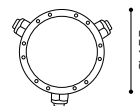

91207 CONNECTOR BOX



accessory; plastic, black
Zubehör; Kunststoff, schwarz
accessoire; plastique, noir

H 50, Ø 155



9 002759 912079



IP68

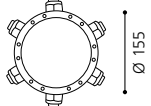



Garden Living

Overview



TERRICO
p. 124



TERRICO
p. 124



TERRICO
p. 124



TERRICO
p. 124



LORENA
p. 126



LORENA 1
p. 126



TERRENO
p. 128



FERROTERRA
p. 128

94334 TERRICO



GL1156



floor luminaire; galvanized steel, brown /
satinated glass, white
Stehleuchte; Stahl verzinkt, braun /
Glas satiniert, weiss
lampadaire; acier galvanisé, marron /
verre satiné, blanc

H 270, Ø 370, Base: Ø 230



9 002759 943349

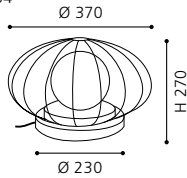
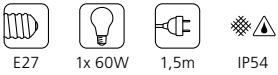

GL1156

94335 TERRICO



GL1156



floor luminaire; galvanized steel, black /
satinated glass, white
Stehleuchte; Stahl verzinkt, schwarz /
Glas satiniert, weiss
lampadaire; acier galvanisé, noir /
verre satiné, blanc

H 310, Ø 315, Base: Ø 230



9 002759 943356

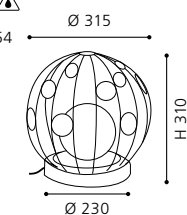
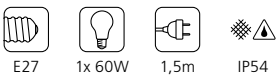

GL1156

94333 TERRICO



GL1156



floor luminaire; galvanized steel, black /
satinated glass, white
Stehleuchte; Stahl verzinkt, schwarz /
Glas satiniert, weiss
lampadaire; acier galvanisé, noir /
verre satiné, blanc

H 580, Ø 305, Base: Ø 230



9 002759 943332

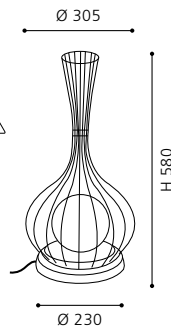
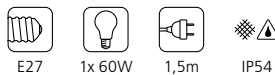

GL1156

94332 TERRICO



GL2720



floor luminaire; galvanized steel, brown /
satinated glass, white
Stehleuchte; Stahl verzinkt, braun /
Glas satiniert, weiss
lampadaire; acier galvanisé, marron /
verre satiné, blanc

H 750, Ø 230, Base: Ø 230



9 002759 943325

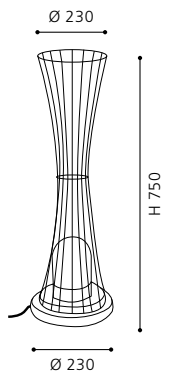
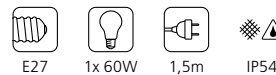

GL2720



89326 LORENA 1



GL2091



89173 LORENA



GL-805



floor luminaire; galvanized steel, antique brown / glass, champagner
Stehleuchte; Stahl verzinkt, antik-braun / Glas, champagner
 lampadaire; acier galvanisé, marron antique / verre, champagne

H 580, Ø 215, Base: Ø 180

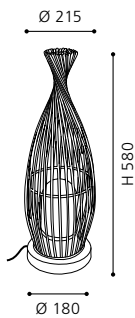
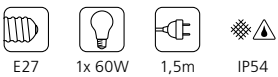

GL2091

floor luminaire; galvanized steel, antique brown / opal glass, white
Stehleuchte; Stahl verzinkt, antik-braun / Glas opal-matt, weiss
 lampadaire; acier galvanisé, marron antique / verre opale, blanc

H 1130, Ø 600, Base: Ø 250

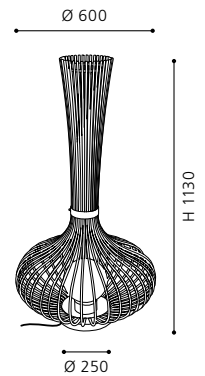
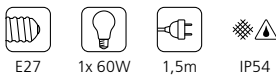

GL-805



89565 FERROTERRA



GL-805



floor luminaire; galvanized steel, black, patina silver / opal glass, white
 Stehleuchte; Stahl verzinkt, schwarz, silber-patina / Glas opal-matt, weiss
 lampadaire; acier galvanisé, noir, argent patiné / verre opale, blanc

H 450, Ø 452, Base: Ø 195

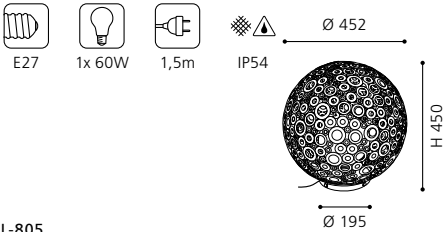

GL-805

91436 TERRENO



GL-805



floor luminaire; galvanized steel, black, patina silver / opal glass, white
 Stehleuchte; Stahl verzinkt, schwarz, silber-patina / Glas opal-matt, weiss
 lampadaire; acier galvanisé, noir, argent patiné / verre opale, blanc

H 900, Ø 380

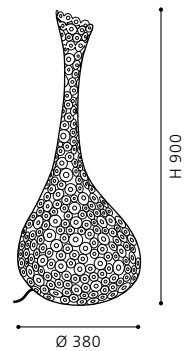
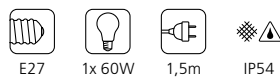

GL-805





Sensor



With automatically turned on light you can improve safety - minimize risks like slipping or stumbling in the dark.

You will find an overview of our sensor luminaire range on the next page.

Der Einsatz von automatisch einsetzender Beleuchtung unterstützt Ihre Sicherheit - Sie entschärfen Gefahrenquellen wie Glätte oder Stolpern in der Dunkelheit.

Einen Überblick über unser Sensorleuchten-Sortiment finden Sie auf der nächsten Seite.

Avec automatiquement mis sur la lumière, vous pouvez améliorer la sécurité - de minimiser les risques de glisser ou trébucher comme dans l'obscurité.

Vous trouverez un aperçu de notre gamme de luminaire capteur à la page suivante.

Classic



LISIO
p. 89



SIDNEY
p. 90



SIDNEY
p. 90



NAVEDO
p. 97



NAVEDO
p. 100



LATERNA 5
p. 103



LATERNA 4
p. 105

Modern



TRONO 2
p. 13



TRONO STICK
p. 13



TRONO 1
p. 13



HELSINKI
p. 20



HELSINKI
p. 20



HELSINKI
p. 21



PANAMA 1
p. 24



NISIA
p. 28



CITY LED
p. 46



CITY
p. 47



CITY
p. 47



CITY 1
p. 47



CERNO
p. 48



CERNO
p. 48



TRABADA
p. 50



TRABADA
p. 50

Spots, Recessed & Function



FAEDO 1
p. 112



FAEDO 1
p. 112



FAEDO 1
p. 112



FAEDO 1
p. 113



FAEDO
p. 114



FAEDO
p. 114



FAEDO
p. 114



GAVELLO
p. 115



ALEGA
p. 115



ALEGA
p. 115



DETECT ME
p. 120



DETECT ME
p. 120

Legend

ARTICLE NUMBER
ARTIKELNUMMER
NUMÉRO D'ARTICLE

SENSOR
SENSOR
SENSOR

This symbol indicates luminaires with a sensor. In addition the sensor angle, sensor distance and lighting duration (min./max.) is indicated.

Ist die Leuchte mit einem Sensor ausgestattet, wird dies durch ein Sensorsymbol gekennzeichnet. Zusätzlich werden Ausstrahlungswinkel, Sensorreichweite und Einschaltedauer (max./min.) angegeben.

Un produit avec cette symbole ont une détecteur de mouvement. Aussi le angle d'émission, la portée et la durée sont indiqués.

DESCRIPTION
BESCHREIBUNG
DESCRIPTION

The product description is composed as follows: luminaire type; enclosure material, enclosure colour / glass or shade material, glass or shade colour

Die Produktbeschreibung setzt sich wie folgt zusammen: Leuchtenart; Gehäusematerial, Gehäusefarbe / Schirm- bzw. Glasmaterial, Schirm- bzw. Glasfarbe

La description du produit est composée comme suit: type de luminaire; matériel de boîtier, couleur de boîtier / matériel de verre ou abat-jour, couleur de verre ou abat-jour

DIMENSIONS
DIMENSIONEN
DIMENSIONS

all dimensions in mm | alle Größen in mm | toutes dimensions en mm

L = length | Länge | longueur
B = width | Breite | largeur
H = height | Höhe | hauteur
Ø = diameter | Durchmesser | diamètre
A = projection length | Ausladung | amplitude
ET = installation depth | Einbautiefe | profondeur utile
Base = base dimensions | Sockelmaße | dimensions de base

Attention! The dimensions relate solely to the sizes of the luminaire. Any air spaces that would be relevant for a safe operating of the lamp were not considered.

Achtung! Die Größen beziehen sich nur auf die Abmessungen der Leuchte. Etwaige Lufträume, die für einen sicheren Betrieb der Leuchte notwendig sind, werden nicht berücksichtigt.

Attention! Les dimensions se réfèrent à la taille de la lampe seulement. Espacements éventuels, que seraient importants pour une opération de la lampe sans danger, n'ont pas été considérés.

PICTOGRAMMES
PIKTOGRAMME
PICTOGRAMMES

Technical details are represented as pictograms. An overview over all pictograms can be found on the next pages.

Technische Details werden als Piktogramme dargestellt. Eine Übersicht über alle Piktogramme finden Sie auf den nächsten Seiten.

Les détails techniques sont représentés sous forme de pictogrammes. Vous trouverez un aperçu de tous les pictogrammes dans les pages suivantes.

SERIES NAME
SERIENNAME
NOM DE LA SÉRIE

CAMERA
KAMERA
CAMÉRA

A product with the camera symbol is separately shown in an ambience picture.

Ein Produkt mit dem Kamerasymbol ist separat in einem Ambientebild abgebildet.

Un produit avec le symbole de caméra est représenté séparément dans une image d'ambiance.

LED
LED
LED

Only high-quality LED illuminants, stripes and boards are used for this luminaire.

Bie dieser Leuchte werden nur hochwertige LED Leuchtmittel, Bänder oder Platinen eingesetzt.

Seulement des ampoules LED, des bandes ou des platines de haute qualité sont utilisés pour ces luminaires.

BUTTONS
BUTTONS
BOUTONS

LED colour | LED Farbe | couleur de LED



EEL bulbs not included | Leuchtmittel exklusive | ampoules non comprises



EEL bulbs included | Leuchtmittel inklusive | ampoules comprises



EEL Erklärung | Description | Description p. 120-121

SKETCHES
SKIZZEN
CROQUIS

The sketches state the most meaningful dimensions. If a product is adjustable by will, a turquoise arrow marks this function and only the maximum dimensions are indicated.

Die Bemessung der Skizzen umfasst jeweils die aussagekräftigsten Größen. Bei verstellbaren Produkten kennzeichnet ein türkis Pfeil diese Funktion und nur die maximalen Größen werden angegeben.

Les dimensions des croquis comprennent les plus représentatives. Si un produit est réglable au choix, une flèche turquoise affiche cette fonction et rien que les dimensions maximales sont indiquées.

SPARE PARTS
ERSATZTEILE
PARTS DE REMPLACEMENT

If a product has spare parts they are marked on the photograph with their corresponding article number.

Wenn zu einem Produkt Ersatzteile vorhanden sind, werden diese in der Abbildung mit deren Artikelnummer markiert.

Si un produit a des parts de remplacement, elles sont marquées dans la photo.

93519 PANAMA 1

wall luminaire; cast aluminium, anthracite / plastic, white
Wandleuchte; Aluguss, anthrazit / Kunststoff, weiss
applique; aluminium moulé, anthracite / plastique, blanc

L 110, H 345, A 285

GX53 1x 7W 1x 550 lm

ET0725

SWITCHES

SCHALTER

INTERRUPTEURS



internal dimmer
eingebauter Dimmer
variateur intégré



rocker switch
Wippschalter
interrupteur à bascule



pull switch
Zugschalter
interrupteur à tirer



pedal switch
Trittschalter
interrupteur à pied



pedal dimmer
Trittdimmer
variateur à pied



button switch
Druckknopf
interrupteur de pression



cable switch
Kabelschalter
interrupteur à câble



sensor
Sensor
sensor



remote control
Fernbedienung
télécommande



This luminaire can be switched on/off and dimmed by touching the specially designed "Touch Me" part of the fixture.

Diese Leuchte kann ein- bzw. ausgeschaltet und gedimmt werden, indem man sie an den dafür vorgesehenen „Touch Me“ Bereichen berührt.

Ce luminaire peut être éteint, allumé et gradué simplement en touchant la partie spécialement conçue pour «Touch Me» du luminaire.



The different lighting atmospheres can be adjusted with a conventional light switch. By pressing the switch in quick succession the luminaire changes between the different atmospheres (see below), by pressing the switch slowly the luminaire turns on or off. The last setting will then be saved.

Die unterschiedlichen Lichtstimmungen der Leuchte können mit einem herkömmlichen Lichtschalter bedient werden. Durch schnelles Betätigen des Schalters wechselt die Leuchte zwischen den Einstellungen (siehe unten), langsames Drücken schaltet die Leuchte ein bzw. aus. Dabei wird die letzte Einstellung gespeichert.

Les ambiances lumineuses de la lampe peuvent être réglées avec un interrupteur conventionnel. Si l'interrupteur est actionné rapidement, la lampe change entre les ambiances différentes (voir ci-dessous); s'il est actionné lentement, la lampe est éteinte ou allumée. La dernière préférence sera mémorisée.

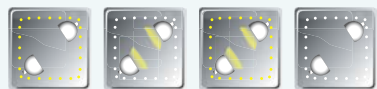

1x

2x

3x

4x

PROTECTION CLASS

SCHUTZKLASSE

CLASSE DE PROTECTION

The protection class indicates to what extent the lamp is protected against electric shock. All lamps in this catalogue are at least protected with the protection class 1 - a higher class is specified in the information box of the respective lamp.

Die Schutzklasse gibt an, inwiefern ein Produkt gegen einen elektrischen Schlag gesichert ist. Alle Leuchten in diesem Katalog sind mit mindestens Schutzklasse 1 gesichert, bei höheren Klassen wird das Symbol im Infokasten der Leuchte angegeben.

La classe de protection indique, dans quelle mesure la lampe est protégée contre les chocs électriques. Tous les lampes dans ce catalogue sont protégées au moins avec la classe 1 - une classe plus élevée est indiquée dans l'information de la lampe.



protection class 1: protective earthing
Schutzklasse 1: Schutzerdung
classe de protection 1: prise de terre



protection class 2: protective insulation
Schutzklasse 2: Schutzisolierung
classe de protection 2: double isolation ou renforcée



protection class 3: protective low voltage
Schutzklasse 3: Schutzkleinspannung
classe de protection 3: très basse tension de sécurité

PROTECTION RATING

SCHUTZGRAD

INDICE DE PROTECTION

The protection rating ensures the operational safety of luminaires. The first number specifies the extent of the protection against the ingress of foreign bodies; the second number identifies the humidity protection grade. All luminaires in this catalogue are at least protected with the rating IP20 - a higher rating is specified in the information box of the luminaire.

Der Schutzgrad gewährleistet die Betriebssicherheit von Leuchten. Die erste Ziffer des IP Grades beschreibt den Schutzzumfang gegen das Eindringen von Fremdkörpern, die zweite Ziffer informiert über den Grad des Feuchtigkeitsschutzes. Alle Leuchten in diesem Katalog sind mit mindestens Schutzgrad IP20 gesichert, bei höheren Graden wird das Symbol im Infokasten der Leuchte angegeben.

L'indice de protection assure la sécurité opérationnelle des luminaires. Le premier chiffre indique à quel point la protection est efficace contre l'insertion de corps étrangers; le second chiffre indique quant à lui le degré de protection par rapport à l'humidité. Tous les luminaires dans ce catalogue sont protégés au moins avec l'indice IP20 - un indice plus élevé est indiqué dans l'information d'article.



IP33



IP44



IP54



IP65



IP67; IP68

LUMINOUS COLOUR / FLUX

LICHTFARBE / -STROM

COULEUR / FLUX LUMINEUX

The colours of the LED are represented as pictograms (see below), their luminous flux directly beneath. The luminous flux is quoted in lumen and describes the amount of light generated by the LED. The higher the value, the brighter is the lamp.

Die Farben der LED werden als Piktogramm (siehe unten) dargestellt, deren Lichtstrom direkt darunter. Der Lichtstrom wird in Lumen gemessen und gibt die erzeugte Lichtmenge der LED an. Je höher der Wert, desto heller das Produkt.

Les couleurs de LED ont représentés sous forme de pictogrammes, leur flux lumineux directement en dessous. L'unité de flux lumineux est le lumen et il mesure la quantité de lumière générée par les LED. Plus la valeur est élevée, plus la lampe est lumineuse.



warm white (< 3300K)
warmweiß (< 3300K)
blanc chaud (< 3300K)



neutral white (3300K - 5300K)
neutralweiß (3300K - 5300K)
blanc neutre (3300K - 5300K)



cold white (> 5300K)
kaltweiß (> 5300K)
blanc froid (> 5300K)



colour changing
farbwechselnd
changeant de couleur



blue
blau
bleu



tunable white
tunable white
tunable white

FURTHER PICTOGRAMMES

WEITERE PIKTGRAMME

AUTRES PICTOGRAMMES



replaceable LED
austauschbare LED
LED remplaçables



dimmable
dimmbar
graduable



not dimmable
nicht dimmbar
ne pas graduable



corner mounting possible (accessory p. 112)
Eckmontage möglich (Zubehör S. 112)
montage dans le coin possible (accessoire p. 112)



incl. cable & plug
inkl. Kabel & Stecker
incl. câble & connecteur



maximum allowable load
maximal zulässige Belastung
charge maximale admissible













cutout (in mm)
Ausschnitt (in mm)
perçage du panneau (en mm)







packaging / delivery unit
Verpackungs- / Liefereinheit
unité d'emballage / de livraison

Legend



SOCKETS FASSUNGEN DOUILLES

 2GX13	 E14	 E27	 G4	 G5
 G9	 GU5,3	 GU10	 GX53	 R7S
 LED				

LED LAMPS LED LAMPEN LAMPES LED

 E14 C35 LED	E14	 E14 C35 FILA	E14	 E14 C35 TIP LED	E14	 E14 C35 TIP FILA	E14	 E14 G45 LED	E14
 E14 G45 FILA	E27	 E14 R50 LED	E14	 E27 G45 LED	E27	 E27 G45 FILA	E27	 E27 G90 LED	E27
 E27 G95 FILA	E27	 E27 A60 LED	E27	 E27 A60 FILA	E27	 E27 R63 LED	E27	 G4 LED	G4
 G9 LED	G9	 MR16 LED	GU5,3	 GU10 LED	GU10	 GX53 LED	GX53		

FLUORESCENT LAMPS LEUCHTSTOFFLAMPEN LAMPES FLUORESCENTES

 E27 G100 CFL	E27	 T5 TUBE	G5	 T5 RING	2GX13
---	-----	---	----	---	-------

HALOGEN LAMPS HALOGENLAMPEN LAMPES HALOGENES

 E14 C35 ECO	E14	 E14 G45 ECO	E14	 E27 A55 ECO	E27	 E27 R63 ECO	E27	 G4	G4
 G9	G9	 MR16	GU5,3	 GU10	GU10	 GY6,35	GY6,35	 R7S	R7S

INCANDESCENT LAMPS ALLGEBRAUCHSLAMPEN LAMPES À INCANDESCENCE

 E14 C35	E14	 E14 C35 TIP	E14	 E14 G45	E14	 E27 A60	E27	 E14 R50	E14
--	-----	---	-----	---	-----	---	-----	---	-----

All previous catalogues and price lists are no longer valid with the issue of this catalogue. Errors, misprints, model and price changes and technical modifications are reserved. We deliver based on our terms of delivery and payment. Our products comply with the European light norm EN60598. Products with the ENEC test mark are conforming to the guide line 2006/95/EG. Products with additional safety remarks (e.g protection class, IP) are identified within the product family with the relevant symbol and number. The content of this catalogue is protected under copyright law for EGLO Leuchten GmbH. All rights reserved. Our specific written consent must be obtained before using any illustrations and texts. The pictures are 4C prints and may differ from the original.

The product pictures and ambiances in this catalogue can deviate from reality, and they do not necessarily concur with the usual application of the product. EGLO does not assume liability for the correctness, completeness or the application depiction of the products and/or the product information.

Design, layout and composition: EGLO GmbH, A-6136 Pill - AUSTRIA

Print: Alpina Druck GmbH, A-6022 Innsbruck

Pictures: EGLO, istockphoto.com

Mit diesem Katalog verlieren alle vorhergehenden Kataloge und Preislisten ihre Gültigkeit. Irrtümer, Druckfehler, Modell- und Preisänderungen sowie technische Änderungen vorbehalten. Wir liefern zu unseren Liefer- und Zahlungsbedingungen. Unsere Produkte entsprechen der europäischen Leuchtennorm EN 60598. Produkte mit dem ENEC Prüfzeichen sind konform mit der Richtlinie 2006/95/EG. Produkte mit weiteren Sicherheitshinweisen (zB. Schutzklasse, IP) sind mit Symbol und Zahl bei der Produktfamilie ausgezeichnet. Der Inhalt dieses Kataloges ist für die EGLO Leuchten GmbH urheberrechtlich geschützt. Alle Rechte sind vorbehalten. Bilder und Texte dürfen nicht ohne vorherige ausdrückliche, schriftliche Genehmigung verwendet werden. Die Abbildungen sind 4C Drucke und können vom Original abweichen.

Die Katalogbilder und die gezeigten Darstellungen der Produkte können von der Wirklichkeit abweichen und nicht den üblichen Produktanwendungen entsprechen. EGLO übernimmt keine Haftung für die Richtigkeit, Vollständigkeit und Anwendungsdarstellung der Produkte und Produktinformationen.

Gestaltung, Layout und Satz: EGLO GmbH, A-6136 Pill - AUSTRIA

Druck: Alpina Druck GmbH, A-6022 Innsbruck

Bilder: EGLO, istockphoto.com

Le présent catalogue remplace tous les catalogues et tarifs précédents. Sous réserve d'erreurs, de fautes d'impression, de modification des modèles et de changement de prix et de technique. Nous livrons sur la base de nos conditions de livraison et de paiement. Nos produits sont conformes aux normes européennes EN 60598 et portent le marquage CE. Les produits portant la marque ENEC sont conformes à la Directive 2006/95/EG. Les produits portant d'autres indications de sécurité (par exemple classe de protection, IP) sont identifiés par le symbole et le nombre correspondants dans la famille de produits.

Le contenu du présent catalogue est protégé pour la société EGLO Leuchten GmbH par un copyright. Tous droits réservés. Toute reproduction d'images et du texte est interdite sans autorisation explicite par écrit préalable. Les images sont imprimées en 4C et peuvent différer de l'original.

Les images des produits et les ambiances dans le catalogue peuvent dévier de la réalité et ne sont pas nécessairement en ligne avec l'usage habituel du produit. EGLO n'engage pas sa responsabilité sur la justesse des images et sur les informations relatives à l'usage pouvant être fait des produits.

Conception, maquette et composition: EGLO GmbH, A-6136 Pill - AUSTRIA

L'imprimerie: Alpina Druck GmbH, A-6022 Innsbruck

Images: EGLO, istockphoto.com

01-2016

Register

Item no. Art. Nr. Numéro	Page Seite Page									Name Name Nom	Page Seite Page		
3376	94	88152	120	93356	35	94098	17	94813	8	ACATE	42	NAGO	31
4171	106	88153	120	93364	35	94099	16	94817	8	AGOLADA	14	NAVEDO	97-100
4172	107	88487	62	93365	34	94101	16	94818	8	ALAMONTE	66	NEMA	111
4173	107	88489	62	93366	27	94102	16	94819	9	ALAMONTE 1	68	NEMA 1	111
4174	107	88575	116	93367	33	94103	16	94827	66	ALEGA	115	NISIA	28
4175	107	88577	95	93368	32	94104	16	94828	66	ALORIA	80-83	NISIA 1	27
5389	95	88709	90	93369	35	94105	16	94829	66	ALORIA-LED	84	NOCELLA	31
22144	104	88711	90	93384	111	94106	17	94831	68	ANOLA	60-61	OHIO	28
22145	104	88744	120	93385	111	94107	17	94832	68	ARCHA	42	ONJA	58
22462	103	88802	61	93402	82	94108	19	94833	68	ARIOLLA	26-27	ONTANEDA	56
22463	103	88803	60	93403	83	94109	111	94834	76	ASCOLI	14	OUTDOOR	
22464	103	88806	61	93404	82	94111	111	94835	76	BARROSELA	70-72	CLASSIC	106-107
22465	102	88807	60	93405	82	94112	120	94836	76	BASALGO	10	PANAMA 1	24
22466	102	88812	115	93406	80	94114	35	94837	70	BASALGO 1	11	PARDELA	33
22467	105	88813	115	93407	81	94117	42	94838	70	BENACO	52	PARDELA 1	35
22468	105	88814	115	93408	80	94118	22	94841	76	BEVERLY	52	PARK	44
22469	105	88815	115	93409	80	94119	52	94842	74	BOSARO	54	PARK 4	121
22471	104	89173	126	93426	121	94121	56	94843	74	BREGANZO	44	PARK 5	44
22472	104	89314	28	93437	42	94122	27	94844	74	BUCKINGHAM	92	PATERNO	86-87
22995	102	89326	126	93438	38	94123	26	94845	42	CABOS	14	PENALVA	8
22996	102	89366	42	93444	100	94124	52	94848	30	CADIZ 1	21	PENALVA 1	8-9
27126	28	89533	93	93445	100	94125	13	94849	30	CALGARY	23	PIAS	34
30173	48	89535	93	93446	100	94126	13	94851	36	CALGARY 1	35	PORTICI	95
30181	26	89536	93	93447	100	94127	13	94852	50	CERNO	48	PREDAZZO	38
30182	26	89565	128	93448	100	94128	13	94853	50	CITY	47, 62	PULFERO	76
30183	26	89767	58	93451	100	94131	10	94854	78	CITY 1	47	PULFERO 1	78
30184	88	89768	58	93452	99	94132	10	94855	78	CITY 2	56	RAIANO	92
30185	89	89769	58	93453	99	94133	44	94856	78	CITY CLASSIC	95	RALORA	48
30186	88	90121	14	93454	99	94137	44	94857	78	CITY LED	46	RAVARINO	52
30187	88	90184	95	93455	97	94138	44	94858	70	COLINDRES	70	REDONDO	32-33
30188	88	90208	95	93456	97	94139	31	94859	72	COLINDRES 1	71	RIGA	16-17
30191	48	90748	121	93457	97	94141	31	94861	71	CONNECTOR BOX	121	RIGA 1	111
30192	48	90867	62	93458	97	94184	36	94862	71	CORFINO	42	RIGA 2	17-19
30193	47	91096	38	93459	97	94185	36	94863	71	CUBA	120	RIGA 3	118
30194	47	91121	92	93462	97	94186	36	94864	74	DARIL	48	RIGA-LED	18
30199	120	91206	121	93463	98	94208	13	94865	72	DETECT ME	120	ROFFIA	22
30201	120	91207	121	93464	98	94209	13	94866	72	EXIT 1	89	RUSTEGA	32
30205	28	91436	128	93465	98	94212	46	94867	72	FAEDO	114-115	SAN TELMO	95
30206	28	91769	42	93473	114	94213	46	94868	72	FAEDO 1	112-113	SESIMBA	30
30207	28	92335	21	93474	114	94214	87	94871	40	FASTRO	54	SEVILLA	62
30907	56	92342	52	93475	114	94215	86	94872	40	FASTRO 1	54	SIDNEY	90-91
80761	89	92382	31	93476	114	94216	86	94874	40	FERROTERRA	128	SIONES	60
81751	20	92735	18	93477	114	94217	86	94876	40	FONTACINA	10	SOJO	54
81752	20	92736	18	93478	114	94218	86	94877	40	FONTELA	33	SONELLA	40
81753	21	92737	18	93479	115	94277	11	95073	50	GAVELLO	115	SONELLA 1	40
82309	47	92738	18	93481	118	94278	11	95074	50	HELSINKI	20-21	STOCKHOLM 1	111
83278	21	93094	83	93482	118	94279	11	95233	116	HELSINKI-LED	19	TABO	36
83279	20	93095	83	93488	14	94281	11	95234	116	HILBURN	74	TABO-LED	35
83281	20	93096	82	93512	84	94332	124	95235	116	HILBURN 1	72	TERRENO	128
83432	44	93097	81	93513	84	94333	124	95403	112	INFESTO	40	TERRICO	124
83433	44	93098	81	93514	84	94334	124	95404	112	INFESTO 1	40	TRABADA	50
83585	94	93099	80	93515	84	94335	124	95405	112	ISOBA	58	TRONO 1	13
83588	94	93253	38	93516	84	94398	42	95406	113	KIBEA	38	TRONO 2	13
83589	94	93254	38	93517	84	94399	115	95407	112	KONYA	52	TRONO STICK	13
83966	90	93255	33	93518	24	94779	54	95408	112	LAMEDO	118	VENTO	56
83968	91	93256	54	93519	24	94784	56	95409	112	LATERNA 4	104-105	VENTO 1	56
83969	91	93258	58	93521	24	94785	56	95411	113	LATERNA 5	102-103	VOLPINO	42
83971	90	93259	58	93522	24	94786	66			LATERNA 7	94-95	ZAMORANA	36
83998	17	93261	60	93523	24	94787	66			LAVORIA	31	ZIMBA	116
84002	17	93262	60	93553	27	94788	68			LEPUS	62	ZIMBA-LED	116
86189	118	93263	60	93991	54	94789	68			LISIO	88-89		
86248	52	93264	60	93992	92	94792	71			LORENA	126		
86385	52	93267	56	93993	38	94793	36			LORENA 1	126		
86387	23	93268	111	93994	38	94794	36			MALGERA	44		
86388	23	93269	10	93996	32	94796	30			MARGO	118		
86389	23	93271	14	93998	54	94797	48			MELGOA	71		
86541	52	93317	33	93999	54	94798	48			MILTON	62, 94		
87105	90	93318	33	94086	48	94802	14			MILTON 1	94		
87184	44	93319	32	94087	22	94803	14			MINORCA	93		
88008	116	93325	34	94088	22	94804	14			MIRANO	42		
88119	62	93326	34	94089	31	94805	70			MORINO	14, 32-33, 38		
88139	47	93328	19	94091	56	94807	92			MOUNA	26		
88142	47	93329	19	94092	118	94811	8			NABILA 1	92		
88144	47	93331	19	94093	118	94812	8			NADELA	38, 42		



EGLO
my light | my style

EGLO Leuchten GmbH
Heiligkreuz 22
A-6136 Pill
Austria
Tel. +43 (0) 5242 6996
Fax +43 (0) 5242 6996-938
info@eglo.com
www.eglo.com

KATA16



www.eglo.com