

Leuchten – Qualität made in Germany



HOLTKÖTTER

HOLTKÖTTER[®]
The Ultimate Lighting Machines[™]

HOLTKÖTTER

www.holtkoetter.com

Distribution Center

Holtkoetter International, Inc.
205 Hardman Avenue South
South Saint Paul, MN 55075

Administrative Offices

Holtkoetter International, Inc.
155 Hardman Avenue South
South Saint Paul, MN 55075

Mailing Address

Holtkoetter International, Inc.
P.O. Box 623
South Saint Paul, MN 55075

Administration/Accounts Receivable

Toll-free Phone: (888) 834-7234
Toll-free Fax: (888) 552-8661
Phone: (651) 552-8620
Fax: (651) 450-1907

Customer Service

Toll-free Phone: (800) 899-5444
Toll-free Fax: (888) 552-8661
Phone: (651) 552-8776
Fax: (651) 552-8661

Showroom

Dallas International Lighting Market
Dallas Trade Mart, Showroom #4600
Dallas, TX 75207

Other Showrooms/Lighting Markets

- Frankfurt, Germany
- Liesborn, Germany
- South Saint Paul, Minnesota

Schutzgebühr US \$18.00

CHAIRSIDE READING	04
TABLE, DESK & TASK LAMPS	60
VOLKSLAMPE	88
LICHTSTAR SYSTEM	98
PENDANTS & CONTEMPORARY CHANDELIERS	132
CEILING	150
BATH & DECORATIVE SCONCES	166
SWING-ARM WALL SCONCES	182
PICTORIAL TABLE OF CONTENTS	202
NUMERICAL INDEX	208

The Ultimate Lighting Machines.™
The Ultimate LED.™

THE HOLTKÖTTER DIFFERENCE

Leuchten - Qualität made in Germany

A lamp or lighting fixture for us is not only a decorative accessory or even a decorative work of art, but first and foremost a functional product.

“LICHT MACHEN” (to make light) is our first responsibility, Mr. Holtkötter used to say. Once this function is fulfilled, a beautiful form will follow, made with precious materials and dedicated workmanship.



The Young Man Reading by Candlelight, Matthias Stomer, Swedish National Museum, Stockholm.

Our intellectual heritage comes from the bauhaus school of thought. To clad the function of “Licht machen” into a beautiful form using precious materials and workmanship has been taught to us by the bauhaus school of Germany and its intellectual forefathers in the Arts and Crafts movements in various European countries as well as here in America.



Werkstättentrakt Bauhaus Dessau

The light bulb is the starting point for “Licht machen.” We try to use only the best, mainly light bulbs made by Osram of Munich, Germany. But there is more: dimmability, electrical conductivity, focussing and reflective functionality, or sometimes just physical beauty of the lamp or lighting fixture as a decorative work of art.

A form becomes truly beautiful when it is reduced to its functional necessities. Many of our designs were developed in this way and over the course of time have become trademarks.

The materials used are mainly fine brass, carefully brushed, polished, bronzed, or otherwise finished and then lacquered to the highest standard possible. We do not skimp on the material. Paul likes to say, “If we sold lighting by the pound, we would be the least expensive ones around.”



Holtkötter reflector for 2505 and 2508. An elliptical shape maximizes light output.

The hand-made quality found in Holtkötter products is nothing less than having the utmost respect for the product and to manufacture to the highest standard possible. To maintain our quality and workmanship standards, we have a multitude of quality checks during every step of the manufacturing process.

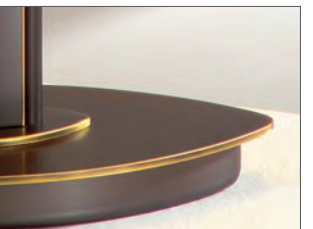

To achieve the perfect bronze finish, many steps in the finishing process have to be accomplished in a perfect way.



Chrome dimmer knob detail.

The result is perfect lighting for your home, church or business, accommodating and enhancing all design environments, going beyond trends, Holtkötter products span the artistic spectrum from traditional to contemporary.

HOLTKÖTTER
The Ultimate Lighting Machines™



CHAIRSIDE READING

CUTTING-EDGE LED TECHNOLOGY

Holtkoetter continues to develop technologies that help improve the quality of light available to consumers while reducing energy use and improving functionality of the lighting product.

One technology being thoroughly investigated is the use of LEDs in current and new products to provide the most efficient and highest quality light.

Currently, the LED light source is a direct lighting source in most applications. However, using the LED in new ways, Holtkoetter has developed an interesting way to provide both direct and indirect (ambient) lighting using the LED.

By placing LEDs in patterns that mitigate glare and prevent shadows, the new 2508*LED P1 reflector

(shown on the left) is the most cutting-edge technology on the LED lighting market today.

The results are:

- perfect light distribution
- unsurpassed light quality and quantity
- no glare
- high-contrast, shadow-free light.

Holtkoetter will continue to research and develop products such as this to provide high-quality lighting and lamping products.



9602*LED
TWO-TONE LED

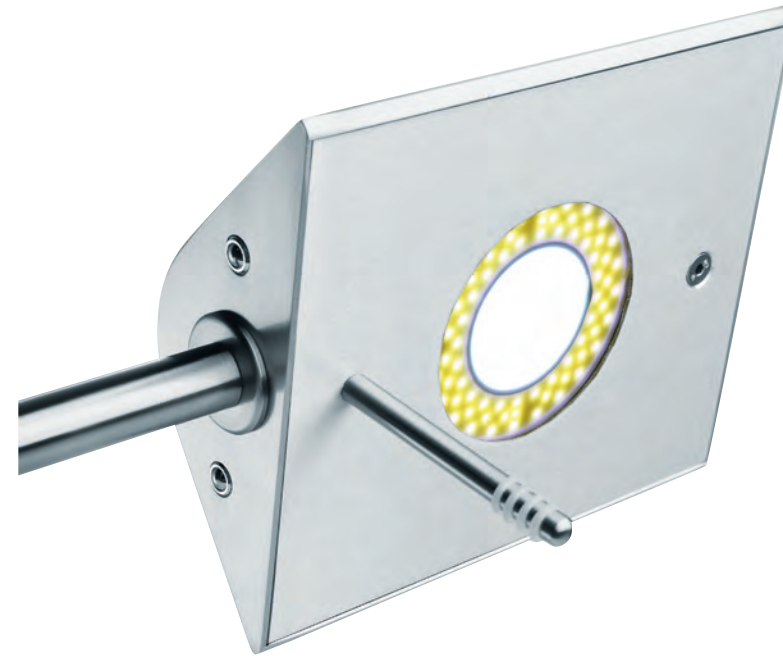

9602 LED Detail
LED Configuration / Dimmer Locations

FINISH OPTIONS

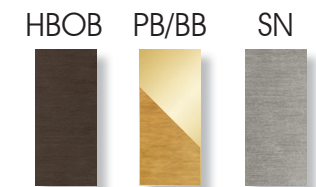

DIMENSIONS

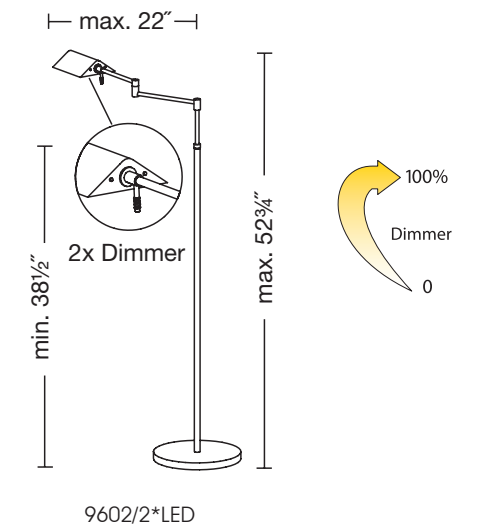

DIMMER FEATURES

Independent Dimming For Each LED Type
LED Color Temperature Ratios:

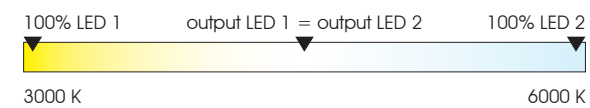

LED SPECIFICATIONS

- Light Engine:** Holtkötter PC Board LED 13-2 with Two-Tone LED Technology
- Optic / Reflector:** Holtkötter Aluminum Reflector with precise Color Blend Optics
- Light Output:** 525 / 595 Lumens (Σ 1120) equivalent to 80 W Halogen
- Light Color:** 3000 / 6000 Kelvin
- Control / LED Driver / Dimmer:** Holtkötter Dimm-System LED with dual full-range dimming of < 1% - 100%
- Maximum Current / Voltage:** 1000mA & 14V
- System Power Consumption:** 2 . . 14 Watts
Equipped with two dimmers on the back of the reflector.



6541*P1 HBOB (l)
6542*P1 HBOB (r)



6541*P1 SN (l)
6542*P1 SN (r)

6541*P1
6542*P1
VIENNESE FLOOR LAMPS

FINISH OPTIONS

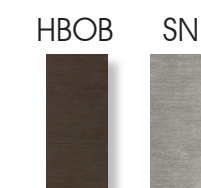

DIMENSIONS / BULBS

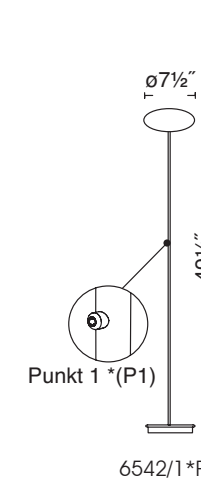

6542*P1: Osram Halopin® 1x
120V/60W - G9 Frosted

820 Lumens
2800 Kelvin

Manufactured by Osram GmbH

9250*060-HPNFR

Equipped with a *P1 dimmer located on the stem.

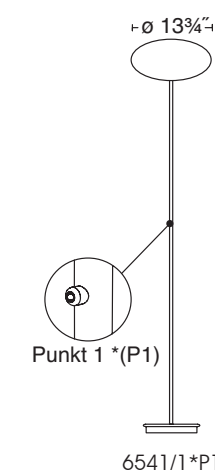
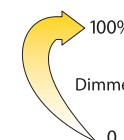

6541*P1: Halolux® Ceram 1x
120V/75W - B15d Clear

1100 Lumens
2900 Kelvin

Manufactured by Osram GmbH

9250*075-DC/CL

Equipped with a *P1 dimmer located on the stem.

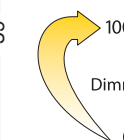

DIMMER FEATURES

The Dimm-System Punkt 1 (*P1) has the following features:

Point Dimming - the lamp may be turned on with a single click of the P1 dimmer.

Soft On - the lamp will come on low and continue to brighten to full brightness. This allows the eye to adjust to a gradual increase in light.

Soft / Delayed Off - turn the lamp off with a single click of the P1 dimmer. The lamp will dim to 60% brightness of the original setting, remaining briefly at that level to allow you to exit the room, then the lamp gradually turns itself off. This "soft" off provides a few moments of light after turning the lamp off, rather than immediate darkness as is the case with other switches.

Dimming Cycle - to adjust the lamp to the perfect light level for any situation, press and hold the P1 dimmer. The dimmer will cycle through all dimming levels. When the lamp achieves the light level of your choice, release the P1 dimmer.



6562 SN SW (l)
 6561 SN SW (m)
 6560 SN SW (r)



6562 HBOB



6561 HBOB



6560 HBOB

6560
 6561
 6562
 VIENNESE FLOOR GLOBES

FINISH OPTIONS

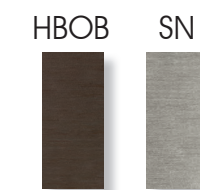

DIMENSIONS / BULBS

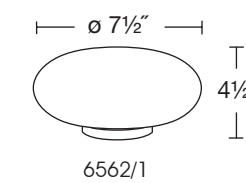

6562: Osram Halopin® 1x
 120V/60W - G9 Frosted

820 Lumens / 2800 Kelvin
 Manufactured by Osram GmbH
 9250*060-HPNFR

Equipped with a Hi-Lo switch.

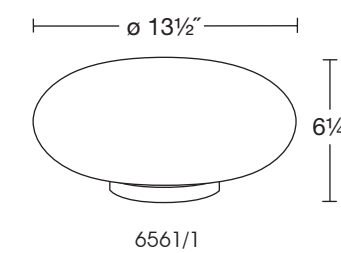

6561: Halolux® Ceram 1x
 120V/75W - B15d Clear

1100 Lumens / 2900 Kelvin
 Manufactured by Osram GmbH
 9250*075-DC/CL

Equipped with a foot dimmer.

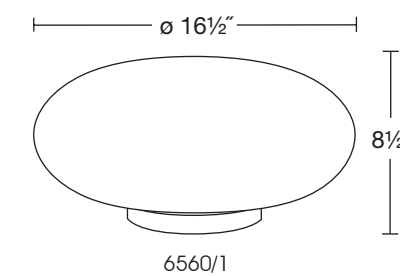
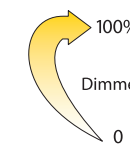

6560: Halolux® Ceram 1x
 120V/100W - B15d Clear

1500 Lumens / 2900 Kelvin
 Manufactured by Osram GmbH
 9250*100-DC/CL

Equipped with a foot dimmer.

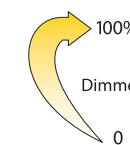

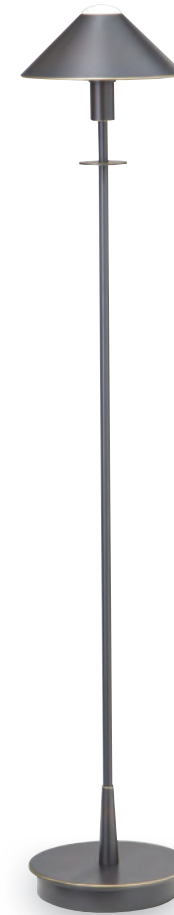

6505 HBOB



6515 SN SW

6505

6515

LIGHTING FOR THE AGING EYE

FINISH OPTIONS

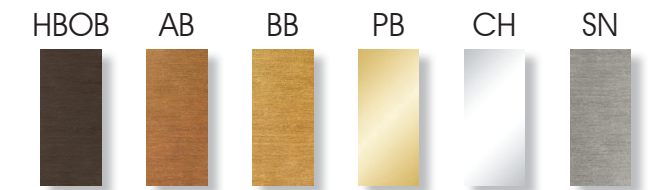

GLASS OPTIONS

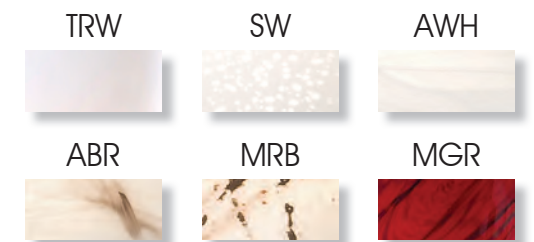

When ordering, please indicate a glass choice for item No. 6515.

DIMENSIONS / BULBS

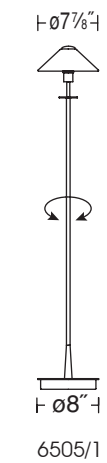

6505/1

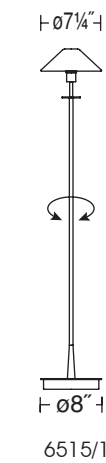

6515/1

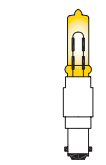

Halolux® Ceram 1x
120V/100W - B15d Clear

1500 Lumens
2900 Kelvin

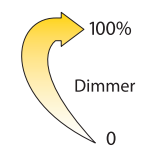

Manufactured by Osram GmbH

9250*100-DC/CL

Equipped with a full-range, turn-knob dimmer. Item 6505/1 in Chrome is supplied with 1x 75W Halolux® Ceram bulb.

RELATED ITEMS





9434 CH TRW



9434 HBOB MGR (l)
9424 HBOB (r)

9424
9434
LIGHTING FOR THE AGING EYE

FINISH OPTIONS

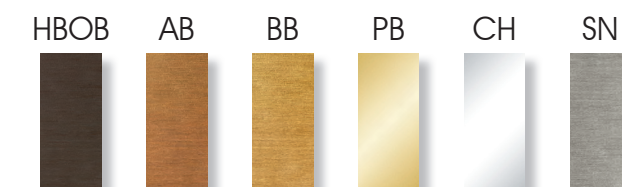

GLASS OPTIONS



When ordering, please indicate a glass choice for item No. 9434.

DIMENSIONS / BULBS

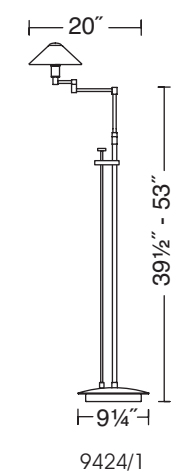

9424/1

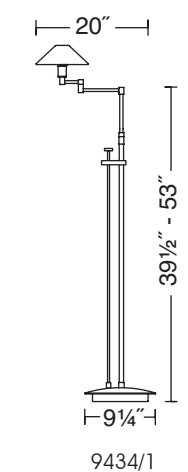

9434/1

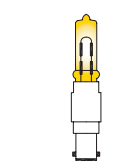

Halolux® Ceram 1x
120V/100W - B15d Clear

1500 Lumens
2900 Kelvin

Manufactured by Osram GmbH

9250*100-DC/CL

Equipped with a full-range, side-line dimmer. Item 9424/1 in Chrome is supplied with 1x 75W Halolux® Ceram bulb.

RELATED ITEMS



6505/6515



9426



6504



6317 CLASSIC



FINISH OPTIONS

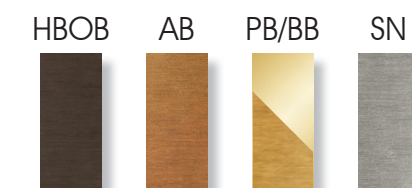

DIMENSIONS / BULBS

6317 Reflector Detail

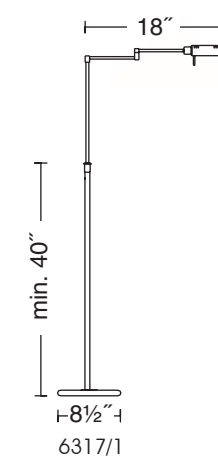

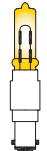
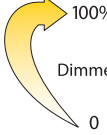
-  Halolux® Ceram 1x
120V/100W - B15d Clear
- 1500 Lumens
2900 Kelvin
-  100% Dimmer
0
- Manufactured by Osram GmbH
- 9250*100-DC/CL
- Equipped with a foot dimmer.

RELATED ITEMS





6317 SLD
SLD - Side Line Dimmer

FINISH OPTIONS

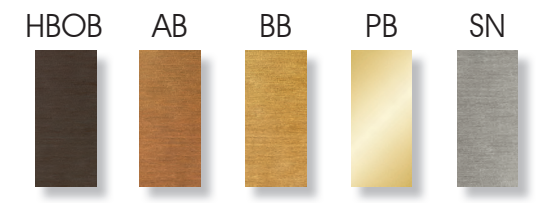

DIMENSIONS / BULBS

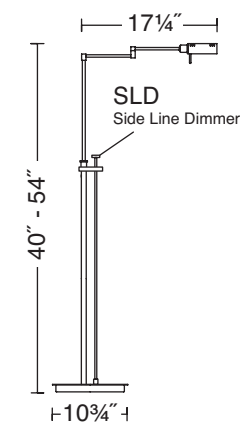

6317/1 SLD

Halolux® Ceram 1x
 120V/100W - B15d Clear
 1500 Lumens
 2900 Kelvin
 Manufactured by Osram GmbH
 9250*100-DC/CL
 Equipped with a full-range, side-line dimmer.

RELATED ITEMS





6317*LED SLD SN



LED Detail

6317*LED SLD
SLD - Side Line Dimmer

FINISH OPTIONS



DIMENSIONS

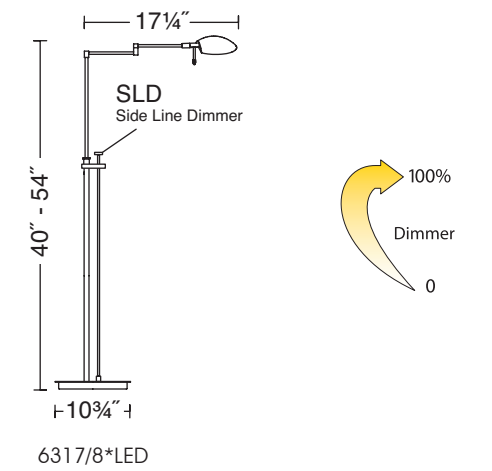

LED SPECIFICATIONS

Light Engine:	Holtkötter PC Board LED 11-8 with 8x CREE XP-G LEDs
Optic / Reflector:	Holtkötter Aluminum Reflector ø 134x100 with 60° x 5mm Optics
Light Output:	1120 Lumens, equivalent to 80 W Halogen
Light Color:	2900 Kelvin
Control / LED Driver / Dimmer:	Holtkötter Side-Line Dimm-System LED with full-range dimming of < 1% - 100%
Maximum Current / Voltage:	1000mA & 14V
System Power Consumption:	2 . . . 14 Watts
	Equipped with a full-range, side-line dimmer.

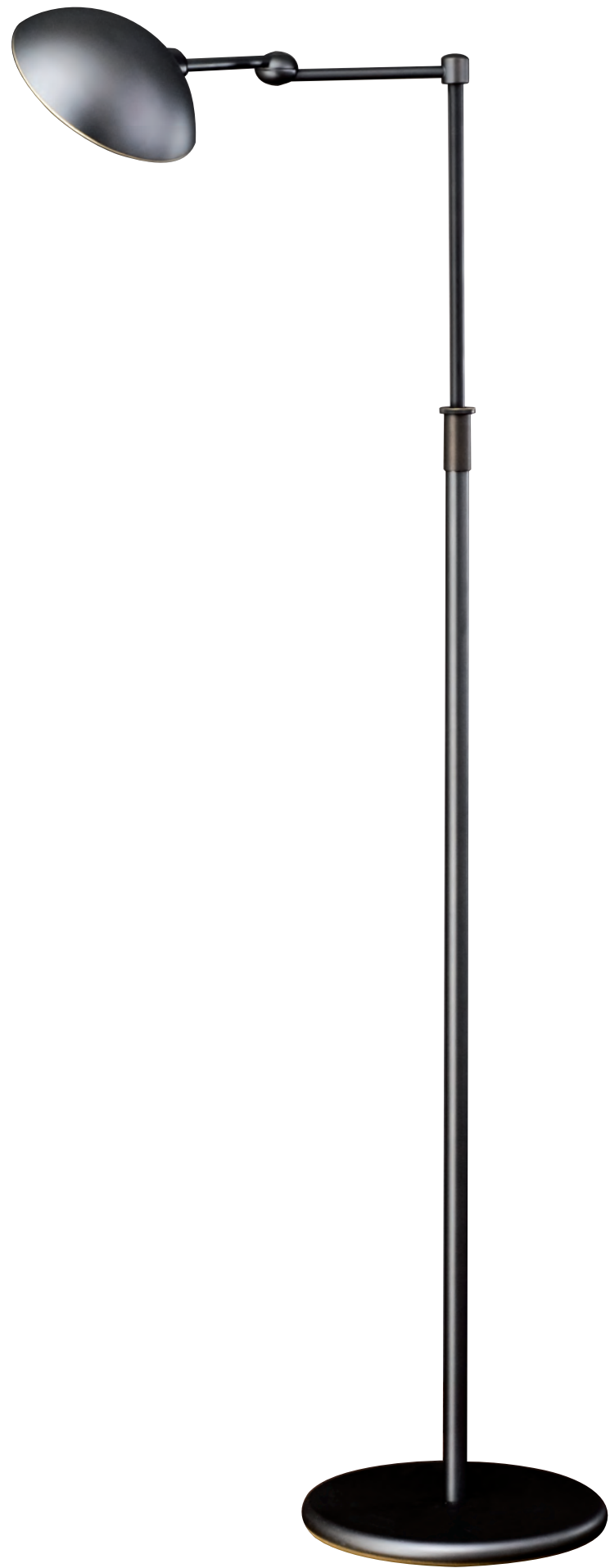

2508 CLASSIC

FINISH OPTIONS

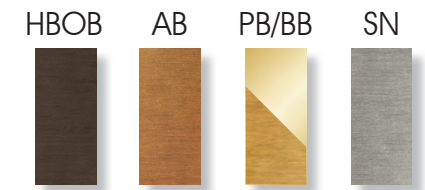

DIMENSIONS / BULBS

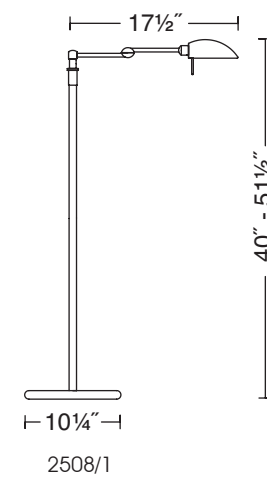

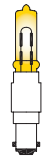

Halolux® Ceram 1x
 120V/100W - B15d Clear

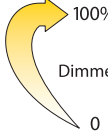
 1500 Lumens
 2900 Kelvin

 100%
 Dimmer
 0
Manufactured by Osram GmbH
 9250*100-DC/CL
 Equipped with a foot dimmer.

RELATED ITEMS

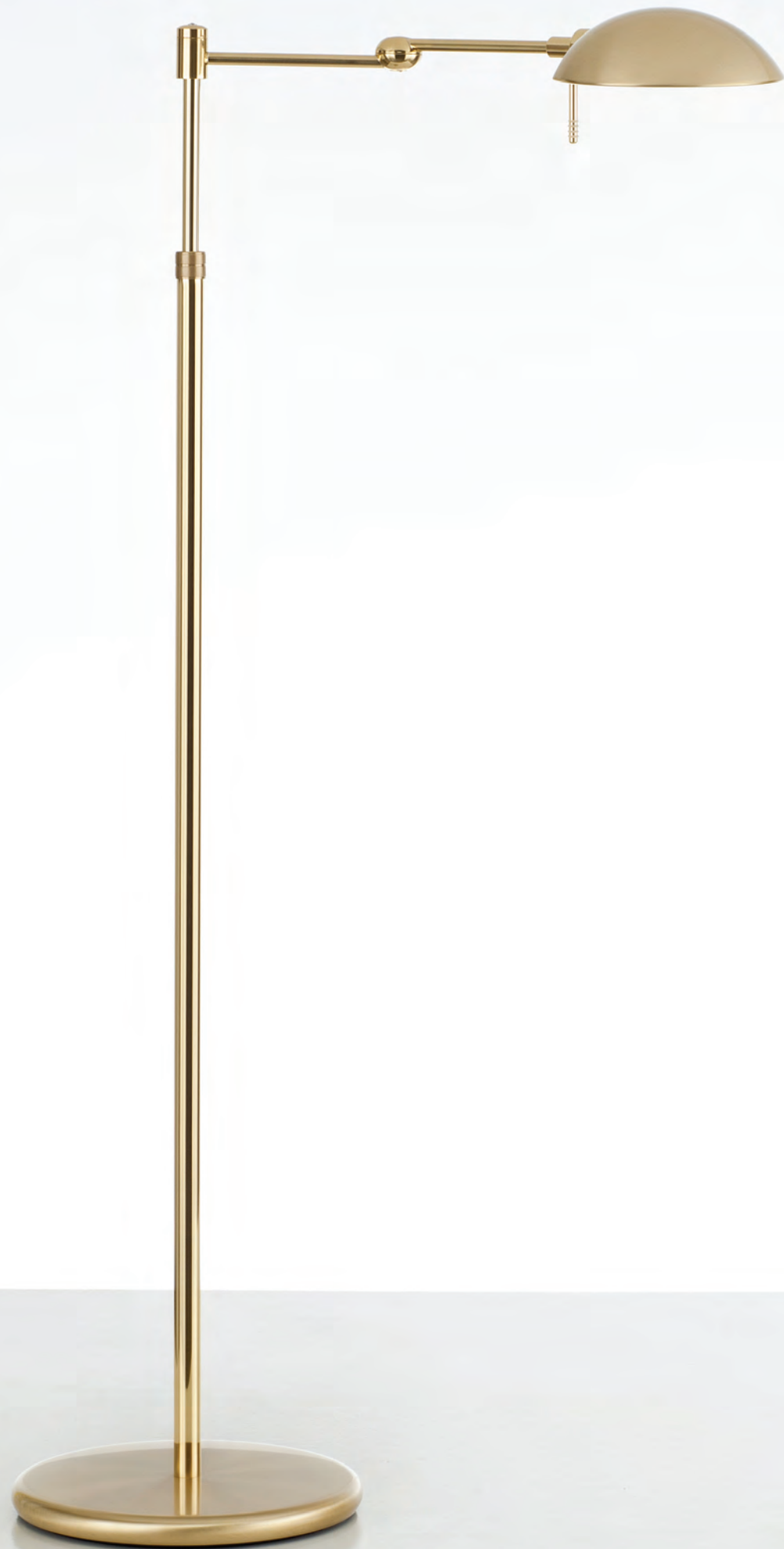



2508*P1

FINISH OPTIONS

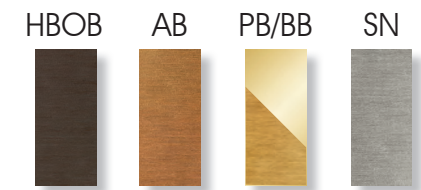

DIMENSIONS / BULBS

Punkt 1* (P1)

19 3/4"

40" - 57"

10 1/4"

2508/1 *P1

Halolux® Ceram 1x
120V/100W - B15d Clear

1500 Lumens
2900 Kelvin

Manufactured by Osram GmbH

9250*100-DC/CL

Equipped with a *P1 dimmer located on the stem.

DIMMER FEATURES

The Dimm-System Punkt 1 (*P1) has the following features:

Point Dimming - the lamp may be turned on with a single click of the P1 dimmer.

Soft On - the lamp will come on low and continue to brighten to full brightness. This allows the eye to adjust to a gradual increase in light.

Soft / Delayed Off - turn the lamp off with a single click of the P1 dimmer. The lamp will dim to 60% brightness of the original setting, remaining briefly at that level to allow you to exit the room, then the lamp gradually turns itself off. This "soft" off provides a few moments of light after turning the lamp off, rather than immediate darkness as is the case with other switches.

Dimming Cycle - to adjust the lamp to the perfect light level for any situation, press and hold the P1 dimmer. The dimmer will cycle through all dimming levels. When the lamp achieves the light level of your choice, release the P1 dimmer.

Tilt Switch - a safety measure is provided with the "Dimm System Punkt 1". In the event that the lamp is tipped over, the tilt switch cuts off the power to the lamp.



2508*LED P1



2508*LED P1 Reflector Detail

FINISH OPTIONS

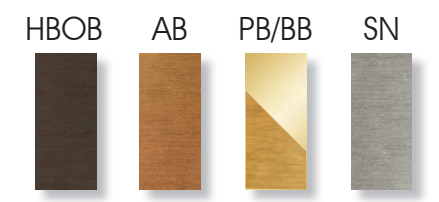

DIMENSIONS

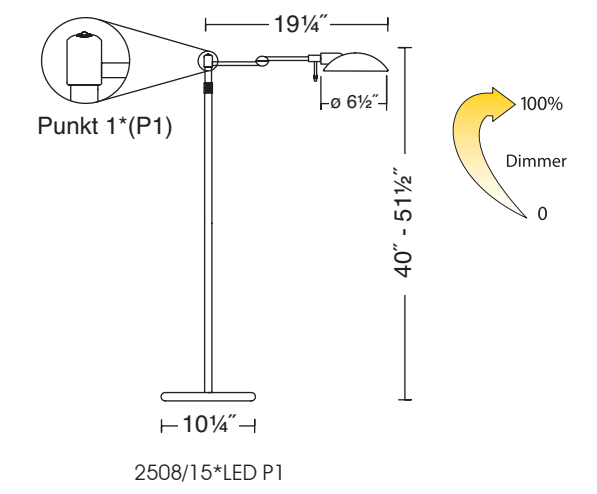

2508/15*LED P1

DIMMER FEATURES

The Dimm-System Punkt 1 (*P1) has the following features:

- Point Dimming** - the lamp may be turned on with a single click of the P1 dimmer.
- Soft On** - the lamp will come on low and continue to brighten to full brightness. This allows the eye to adjust to a gradual increase in light.
- Soft / Delayed Off** - turn the lamp off with a single click of the P1 dimmer. The lamp will dim to 60% brightness of the original setting, remaining briefly at that level to allow you to exit the room, then the lamp gradually turns itself off. This "soft" off provides a few moments of light after turning the lamp off, rather than immediate darkness as is the case with other switches.
- Dimming Cycle** - to adjust the lamp to the perfect light level for any situation, press and hold the P1 dimmer. The dimmer will cycle through all dimming levels. When the lamp achieves the light level of your choice, release the P1 dimmer.

LED SPECIFICATIONS

- Light Engine:** Holtkötter PC Board LED 13-15 with 15x CREE XP-G LED
 - Optic / Reflector:** Holtkötter Aluminum Reflector with 60° x 5mm Optics
 - Light Output:** 1800 Lumens equivalent to 125W Halogen
 - Light Color:** 2950 Kelvin
 - Control / LED Driver / Dimmer:** Holtkötter Dimm-System*P1 LED 1500 with full-range dimming of <0.1% - 100%
 - Maximum Current / Voltage:** 1500mA & 18V
 - System Power Consumption:** 2 . . . 27 Watts
- Equipped with a *P1 dimmer located on the stem.



2505 CLASSIC



Reflector Detail

FINISH OPTIONS

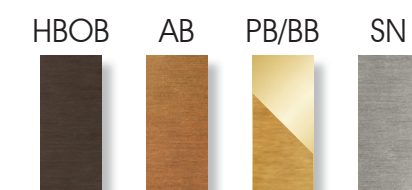

DIMENSIONS / BULBS

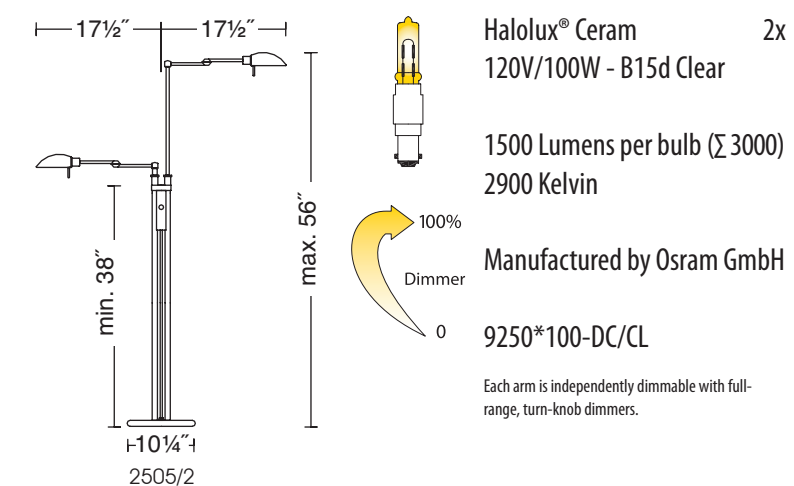

RELATED ITEMS





6450*P1

FINISH OPTIONS

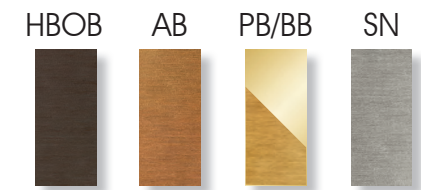

DIMENSIONS / BULBS

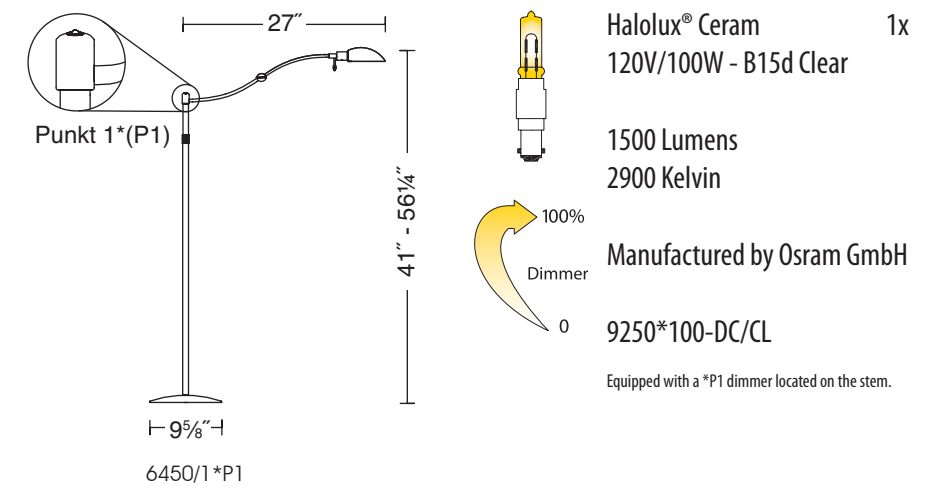

DIMMER FEATURES

The Dimm-System Punkt 1 (*P1) has the following features:

- Point Dimming** - the lamp may be turned on with a single click of the P1 dimmer.
- Soft On** - the lamp will come on low and continue to brighten to full brightness. This allows the eye to adjust to a gradual increase in light.
- Soft / Delayed Off** - turn the lamp off with a single click of the P1 dimmer. The lamp will dim to 60% brightness of the original setting, remaining briefly at that level to allow you to exit the room, then the lamp gradually turns itself off. This "soft" off provides a few moments of light after turning the lamp off, rather than immediate darkness as is the case with other switches.
- Dimming Cycle** - to adjust the lamp to the perfect light level for any situation, press and hold the P1 dimmer. The dimmer will cycle through all dimming levels. When the lamp achieves the light level of your choice, release the P1 dimmer.
- Tilt Switch** - a safety measure is provided with the "Dimm System Punkt 1". In the event that the lamp is tipped over, the tilt switch cuts off the power to the lamp.



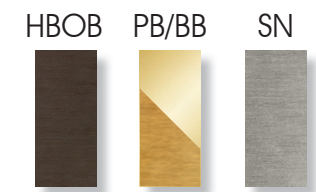

6451

FINISH OPTIONS

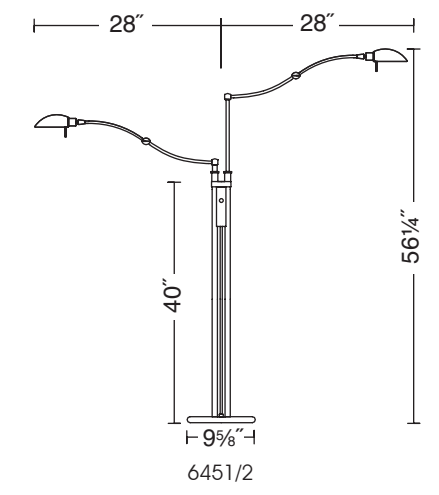

DIMENSIONS / BULBS

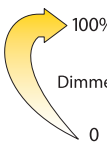

Halolux® Ceram 2x
 120V/100W - B15d Clear
 1500 Lumens per bulb (Σ 3000)
 2900 Kelvin

 100%
 Dimmer
 0
Manufactured by Osram GmbH
9250*100-DC/CL
 Each arm is independently dimmable with full-range, turn-knob dimmers.

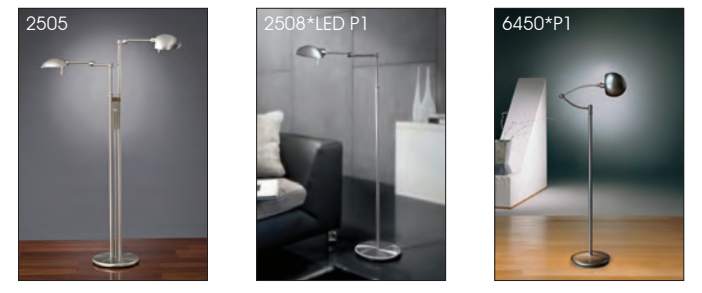
RELATED ITEMS





9680*P1 LED SN

9680*P1 LED



P1 Detail



LED Detail

HOLTKÖTTER
The Ultimate LED™

FINISH OPTIONS

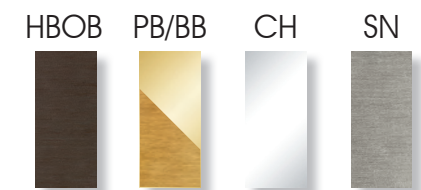

DIMENSIONS

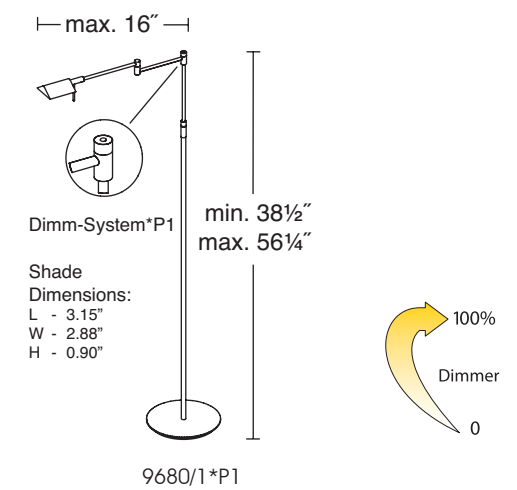

DIMMER FEATURES

The Dimm-System Punkt 1 (*P1) has the following features:

Point Dimming - the lamp may be turned on with a single click of the P1 dimmer.

Soft On - the lamp will come on low and continue to brighten to full brightness. This allows the eye to adjust to a gradual increase in light.

Soft / Delayed Off - turn the lamp off with a single click of the P1 dimmer. The lamp will dim to 60% brightness of the original setting, remaining briefly at that level to allow you to exit the room, then the lamp gradually turns itself off. This "soft" off provides a few moments of light after turning the lamp off, rather than immediate darkness as is the case with other switches.

Dimming Cycle - to adjust the lamp to the perfect light level for any situation, press and hold the P1 dimmer. The dimmer will cycle through all dimming levels. When the lamp achieves the light level of your choice, release the P1 dimmer.

LED SPECIFICATIONS

- Light Engine:** Holtkötter Bridge Board LED 11-1 with 1x Citizen LED
- Optic / Reflector:** Holtkötter Aluminum Reflector 63 x 76 mm with 60° Optics
- Light Output:** 440 Lumens equivalent to 40 W Halogen
- Light Color:** 2900 Kelvin
- Control / LED Driver / Dimmer:** Holtkötter Dimm-System*P1 LED with full-range dimming of <0.1% - 100%
- Maximum Current / Voltage:** 500mA & 7V
- System Power Consumption:** 3.5 Watts

Equipped with a *P1 dimmer located on the stem.



6424*P1 SN



ECO/IRC Detail



LED Detail

6424*P1 Halogen ECO/IRC
6424*LED
BERNIE SERIES

FINISH OPTIONS

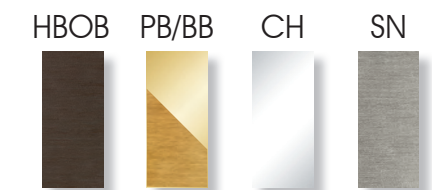

DIMENSIONS / BULBS

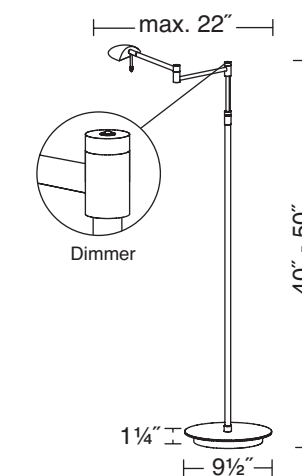

6424/1*P1 & 6424/8*LED

6424*P1 ECO/IRC:
Halostar ECO 1x
12V/60W - GY 6.35 IRC

1650 Lumens
3000 Kelvin

Manufactured by Osram GmbH

9250*060-HSTAR
Equipped with a *P1 dimmer located on the stem.

DIMMER FEATURES

The Dimm-System Punkt 1 (*P1) has the following features:

Point Dimming - the lamp may be turned on with a single click of the P1 dimmer.

Soft On - the lamp will come on low and continue to brighten to full brightness. This allows the eye to adjust to a gradual increase in light.

Soft / Delayed Off - turn the lamp off with a single click of the P1 dimmer. The lamp will dim to 60% brightness of the original setting, remaining briefly at that level to allow you to exit the room, then the lamp gradually turns itself off. This "soft" off provides a few moments of light after turning the lamp off, rather than immediate darkness as is the case with other switches.

Dimming Cycle - to adjust the lamp to the perfect light level for any situation, press and hold the P1 dimmer. The dimmer will cycle through all dimming levels. When the lamp achieves the light level of your choice, release the P1 dimmer.

LED SPECIFICATIONS

Light Engine: Holtkötter PC Board LED 11-8 with 8x CREE XP-G LEDs

Optic / Reflector: Holtkötter Aluminum Reflector ø 134x100 with 60° x 5mm Optics

Light Output: 1120 Lumens, equivalent to 80 W Halogen

Light Color: 2900 Kelvin

Control / LED Driver / Dimmer: Holtkötter Dimm-System *P1 LED with full-range dimming of < 1% - 100%

Maximum Current / Voltage: 1000mA & 14V

System Power Consumption: 2...14 Watt

Equipped with a *P1 dimmer located on the stem.



6470 CH



ECO/IRC Detail



LED Detail



Swivel Detail



Dimmer Detail

6470 Halogen ECO/IRC
6470*LED
BERNIE SERIES

FINISH OPTIONS

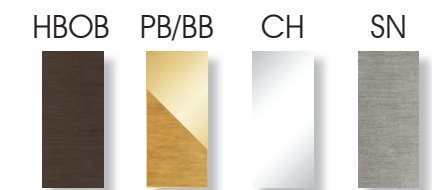

DIMENSIONS / BULBS

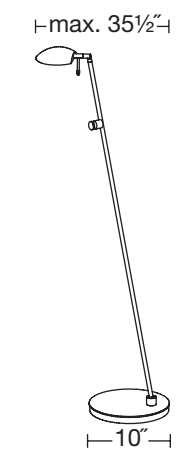

6470/1 & 6470/8*LED

6470 ECO/IRC:
Halostar ECO 1x
12V/60W - GY 6.35 IRC

1650 Lumens
3000 Kelvin

100%
Dimmer
0

Manufactured by Osram GmbH

9250*060-HSTAR
Equipped with a full-range, turn-knob dimmer.

LED SPECIFICATIONS

Light Engine: Holtkötter PC Board LED 11-8 with 8x CREE XP-G LEDs

Optic / Reflector: Holtkötter Aluminum Reflector ø 134x100 with 60° x 5mm Optics

Light Output: 1120 Lumens, equivalent to 80 W Halogen

Light Color: 2900 Kelvin

Control / LED Driver / Dimmer: Holtkötter Dimm-System LED with full-range dimming of < 1% - 100%

Maximum Current / Voltage: 1000mA & 14V

System Power Consumption: 2...14 Watt



6420*P1 Halogen ECO/IRC

FINISH OPTIONS

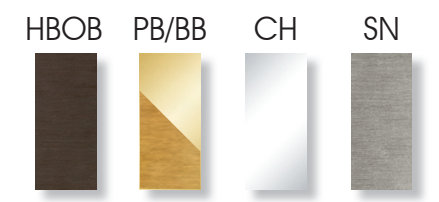

DIMENSIONS / BULBS

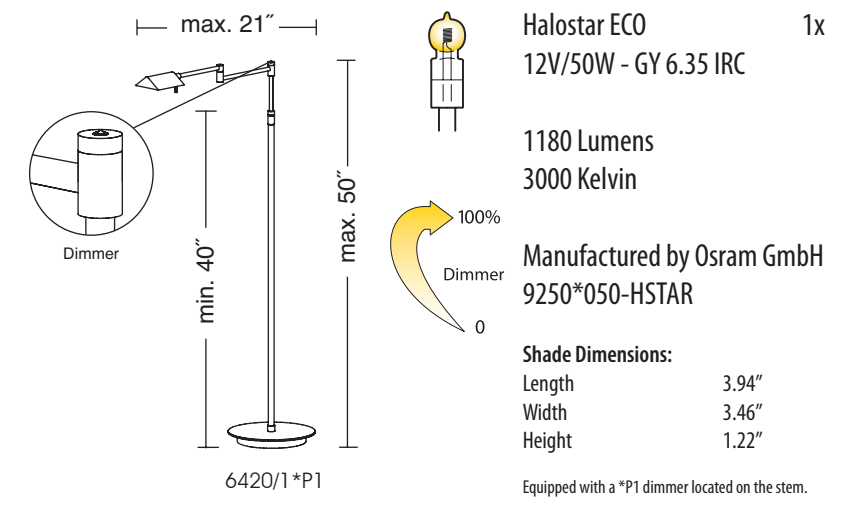

DIMMER FEATURES

The Dimm-System Punkt 1 (*P1) has the following features:

- Point Dimming** - the lamp may be turned on with a single click of the P1 dimmer.
- Soft On** - the lamp will come on low and continue to brighten to full brightness. This allows the eye to adjust to a gradual increase in light.
- Soft / Delayed Off** - turn the lamp off with a single click of the P1 dimmer. The lamp will dim to 60% brightness of the original setting, remaining briefly at that level to allow you to exit the room, then the lamp gradually turns itself off. This "soft" off provides a few moments of light after turning the lamp off, rather than immediate darkness as is the case with other switches.
- Dimming Cycle** - to adjust the lamp to the perfect light level for any situation, press and hold the P1 dimmer. The dimmer will cycle through all dimming levels. When the lamp achieves the light level of your choice, release the P1 dimmer.



6440
BERNIE SERIES

FINISH OPTIONS

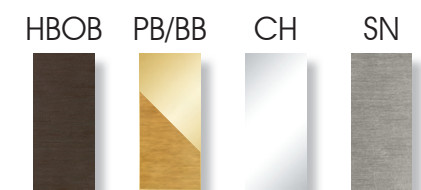

DIMENSIONS / BULBS

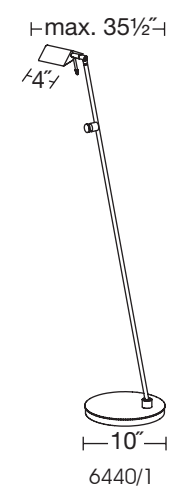

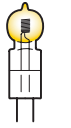
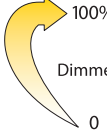
Halostar ECO 1x
 12V/50W - GY 6.35 IRC
 1180 Lumens
 3000 Kelvin
 100% Dimmer
 0
Manufactured by Osram GmbH
 9250*050-HSTAR
 Equipped with a full-range, turn-knob dimmer.

RELATED ITEMS





6263 SN-SWNR (1)
6354 SN-SWNR (1)



6354 HBOB KPRG

6354

FINISH OPTIONS

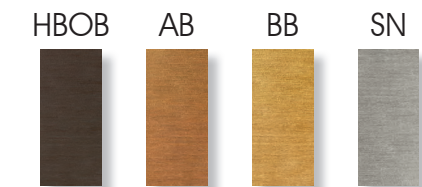

SHADE OPTIONS



DIMENSIONS / BULBS

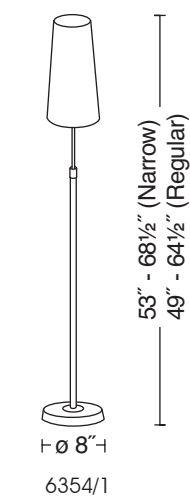

120V/max. 100W* 1x
Medium Base, not included.

Shade Dimensions:	Narrow	Regular
Shade Top ø	4 3/4"	12"
Shade Bottom ø	7 1/4"	15"
Shade Height	14"	12"



Equipped with a foot dimmer.

In order to comply with the laws in the State of California, all shipments of this lamp to the State of California include a compact fluorescent light bulb.

*To preserve the color integrity of the narrow shades, use up to 75W max. or Low UV bulbs.

RELATED ITEMS





2545 SN VGRG

2545 THE ILLUMINATOR

FINISH OPTIONS

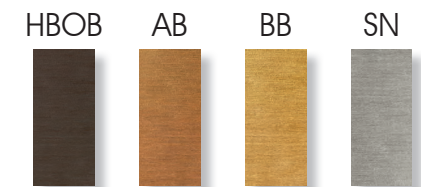

SHADE OPTIONS

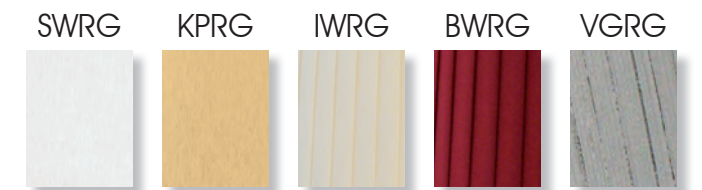

DIMENSIONS / BULBS

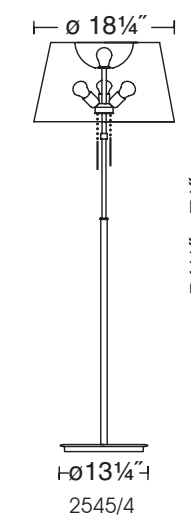

120V/max. 100W 3x
Medium Base, not included.

Illuminator:
120V/max. 150W 1x
3-Way: 50W/100W/150W
Medium Base, not included.

Shade Dimensions:
Shade Top ϕ 15 3/4"
Shade Bottom ϕ 18 1/4"
Shade Height 12 1/2"

Equipped with a pull-chain switch.
In order to comply with the laws in the State of California,
all shipments of this lamp to the State of California include
compact fluorescent light bulbs.

RELATED ITEMS





2541 HBOB BWRG

FINISH OPTIONS

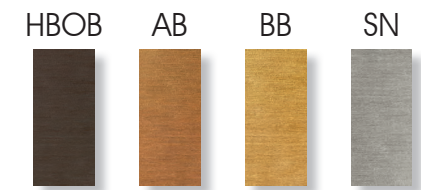

SHADE OPTIONS

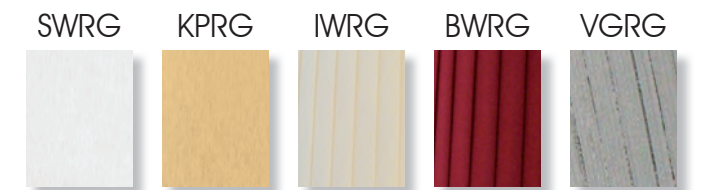

DIMENSIONS / BULBS

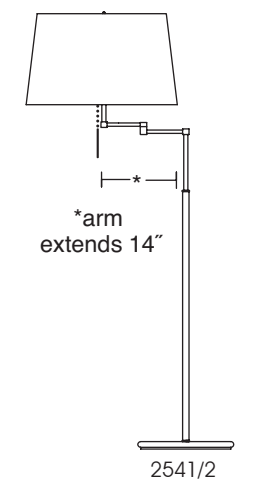

120V/max. 100W 2x
Medium Base, not included.

Shade Dimensions:
Shade Top ø 13 3/4"
Shade Bottom ø 15 3/4"
Shade Height 10"

Equipped with a pull-chain switch.

In order to comply with the laws in the State of California, all shipments of this lamp to the State of California include compact fluorescent light bulbs.

RELATED ITEMS





2625*LED P1 CH

2625*LED P1

FINISH OPTIONS

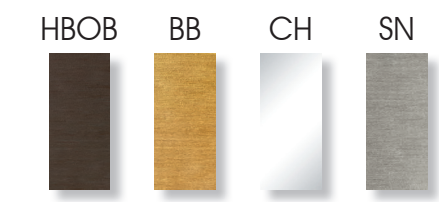

DIMENSIONS

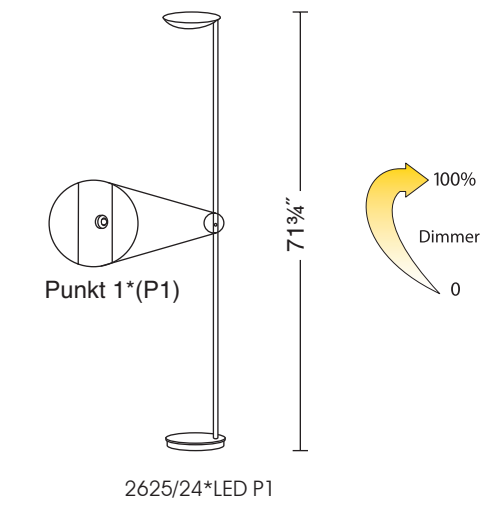

2625/24*LED P1

DIMMER FEATURES

The Dimm-System Punkt 1 (*P1) has the following features:

- Point Dimming** - the lamp may be turned on with a single click of the P1 dimmer.
- Soft On** - the lamp will come on low and continue to brighten to full brightness. This allows the eye to adjust to a gradual increase in light.
- Soft / Delayed Off** - turn the lamp off with a single click of the P1 dimmer. The lamp will dim to 60% brightness of the original setting, remaining briefly at that level to allow you to exit the room, then the lamp gradually turns itself off. This "soft" off provides a few moments of light after turning the lamp off, rather than immediate darkness as is the case with other switches.
- Dimming Cycle** - to adjust the lamp to the perfect light level for any situation, press and hold the P1 dimmer. The dimmer will cycle through all dimming levels. When the lamp achieves the light level of your choice, release the P1 dimmer.

LED SPECIFICATIONS

- Light Engine:** Holtkötter PC Board LED 11-24 with 24x CREE XP-G LED
- Optic / Reflector:** Holtkötter Aluminum Reflector with 60° x 5mm Optics
- Light Output:** 3360 Lumens equivalent to 240 W Halogen
- Light Color:** 2950 Kelvin
- Control / LED Driver / Dimmer:** Holtkötter Dimm-System *P1 LED 1500 with full-range dimming of <0.1% - 100%
- Maximum Current / Voltage:** 1500mA & 28V
- System Power Consumption:** 3 ... 42 Watts

Equipped with a *P1 dimmer located on the stem.



2573 SN

FINISH OPTIONS

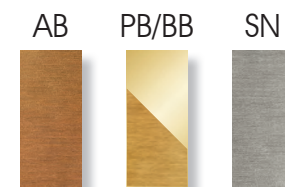

DIMENSIONS / BULBS

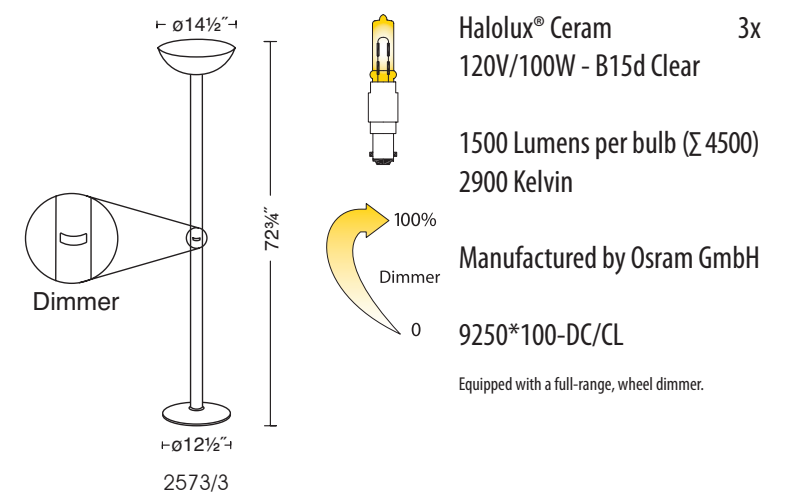

RELATED ITEMS

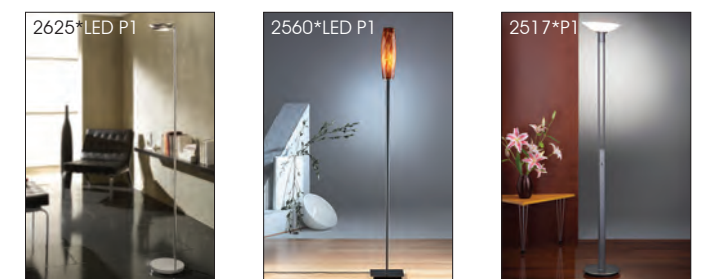



2501 AB

FINISH OPTIONS

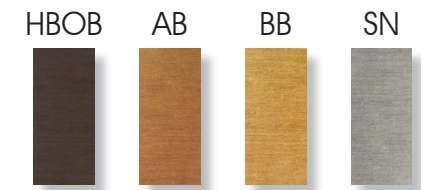

DIMENSIONS / BULBS

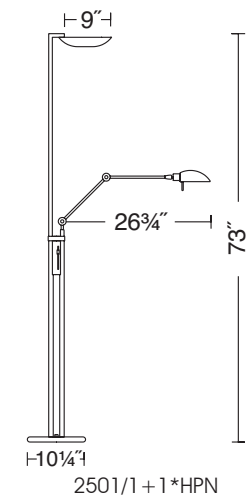

Upper Lamps: 5x
Osram Halopin®
120V/60W - G9 Clear

820 Lumens per bulb (Σ 4100)
2900 Kelvin

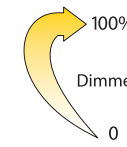

Manufactured by
Osram GmbH

9250*060-HPNCL

Equipped with a Secundum dimmer.

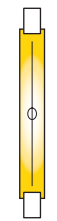

Sidearm Lamp: 1x
Double-Ended Halogen
120V/100W - T3s

1600 Lumens
3000 Kelvin

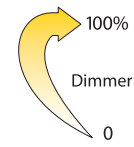

Manufactured by Bulbrite
Industries

9250*100-T3-1/8

Equipped with a Secundum dimmer.

RELATED ITEMS

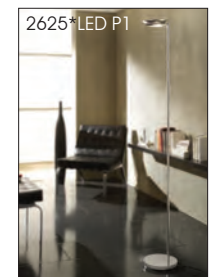



2560*LED P1 HBOB SUN

2560*LED P1

FINISH OPTIONS

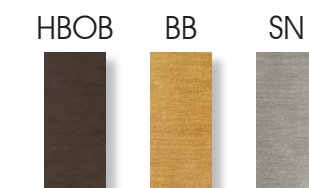

GLASS OPTIONS

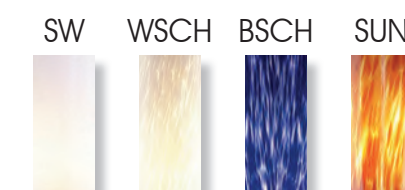

DIMENSIONS

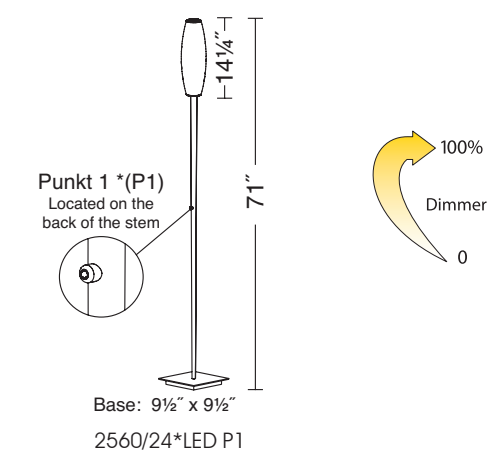

DIMMER FEATURES

The Dimm-System Punkt 1 (*P1) has the following features:

Point Dimming - the lamp may be turned on with a single click of the P1 dimmer.

Soft On - the lamp will come on low and continue to brighten to full brightness. This allows the eye to adjust to a gradual increase in light.

Soft / Delayed Off - turn the lamp off with a single click of the P1 dimmer. The lamp will dim to 60% brightness of the original setting, remaining briefly at that level to allow you to exit the room, then the lamp gradually turns itself off. This "soft" off provides a few moments of light after turning the lamp off, rather than immediate darkness as is the case with other switches.

Dimming Cycle - to adjust the lamp to the perfect light level for any situation, press and hold the P1 dimmer. The dimmer will cycle through all dimming levels. When the lamp achieves the light level of your choice, release the P1 dimmer.

LED SPECIFICATIONS

Light Engine:	3x Holtkötter PC Boards LED 12-8 with 8x CREE XP-G LEDs
Optic / Reflector:	Holtkötter Aluminum Reflector with 60° x 5mm Optics
Light Output:	3360 Lumens equivalent to 240 W Halogen
Light Color:	2950 Kelvin
Control / LED Driver / Dimmer:	Holtkötter Dimm-System P1 LED 1500 with full-range dimming of <0.1% - 100%
Maximum Current / Voltage:	1500mA & 28V
System Power Consumption:	3 ... 42 Watts

Equipped with a *P1 dimmer located on the back of the stem.



2517*P1

FINISH OPTIONS

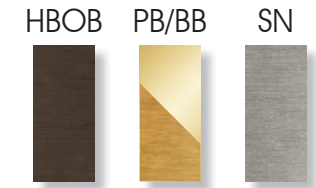

GLASS OPTIONS



DIMENSIONS / BULBS

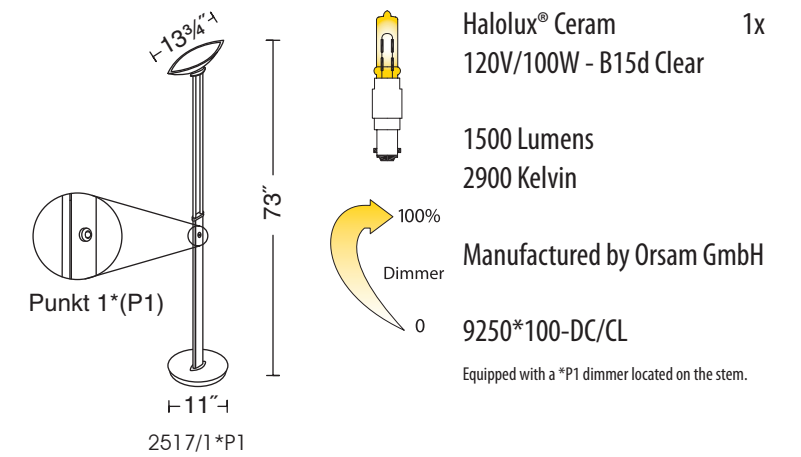

DIMMER FEATURES

The Dimm-System Punkt 1 (*P1) has the following features:

- Point Dimming** - the lamp may be turned on with a single click of the P1 dimmer.
- Soft On** - the lamp will come on low and continue to brighten to full brightness. This allows the eye to adjust to a gradual increase in light.
- Soft / Delayed Off** - turn the lamp off with a single click of the P1 dimmer. The lamp will dim to 60% brightness of the original setting, remaining briefly at that level to allow you to exit the room, then the lamp gradually turns itself off. This "soft" off provides a few moments of light after turning the lamp off, rather than immediate darkness as is the case with other switches.
- Dimming Cycle** - to adjust the lamp to the perfect light level for any situation, press and hold the P1 dimmer. The dimmer will cycle through all dimming levels. When the lamp achieves the light level of your choice, release the P1 dimmer.
- Tilt Switch** - a safety measure is provided with the "Dimm System Punkt 1". In the event that the lamp is tipped over, the tilt switch cuts off the power to the lamp.



TABLE, DESK & TASK LAMPS ●



9603*LED
TWO-TONE LED



9603 Reflector Detail: LED Configuration and Dimmer Locations

FINISH OPTIONS

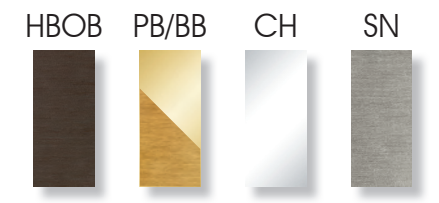

DIMENSIONS

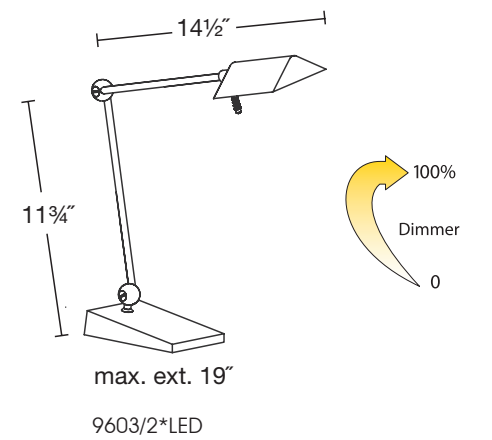

DIMMER FEATURES

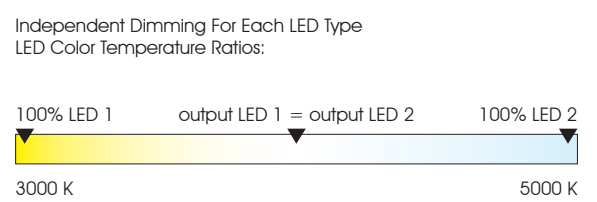

LED SPECIFICATIONS

- Light Engine:** Holtkötter PC Board LED 13-8 with Two-Tone LED Technology
 - Optic / Reflector:** Holtkötter Aluminum Reflector 80 x 96 mm with precise Color Blend Optics
 - Light Output:** 424 / 536 Lumens (Σ 960)
 - Light Color:** 3000 / 5000 Kelvin
 - Control/LED Driver/Dimmer:** Holtkötter Dimm-System LED with Dual Color Control full-range dimming of < 1% - 100%
 - Maximum Current/Voltage:** 1000mA & 8V
 - System Power Consumption:** 2 . . . 8 Watts
- Equipped with two dimmers located on the reflector.

6551*P1
6552*P1
VIENNESE TABLE LAMPS



6551*P1 SN (l)
6552*P1 SN (r)

FINISH OPTIONS



DIMENSIONS / BULBS

6552*P1: Osram Halopin® 1x
120V/60W - G9 Frosted

820 Lumens
2800 Kelvin

Manufactured by Osram GmbH

9250*060-HPNFR

Equipped with a *P1 dimmer located on the base.

6551*P1: Halolux® Ceram 1x
120V/75W - B15d Clear

1100 Lumens
2900 Kelvin

Manufactured by Osram GmbH

9250*075-DC/CL

Equipped with a *P1 dimmer located on the base.

DIMMER FEATURES

The Dimm-System Punkt 1 (*P1) has the following features:

- Point Dimming** - the lamp may be turned on with a single click of the P1 dimmer.
- Soft On** - the lamp will come on low and continue to brighten to full brightness. This allows the eye to adjust to a gradual increase in light.
- Soft / Delayed Off** - turn the lamp off with a single click of the P1 dimmer. The lamp will dim to 60% brightness of the original setting, remaining briefly at that level to allow you to exit the room, then the lamp gradually turns itself off. This "soft" off provides a few moments of light after turning the lamp off, rather than immediate darkness as is the case with other switches.
- Dimming Cycle** - to adjust the lamp to the perfect light level for any situation, press and hold the P1 dimmer. The dimmer will cycle through all dimming levels. When the lamp achieves the light level of your choice, release the P1 dimmer.



6469 HBOB

6469
BERNIE SERIES

FINISH OPTIONS

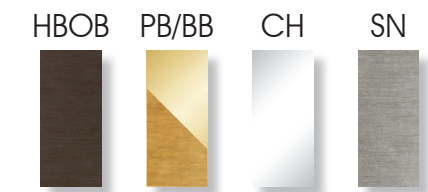

DIMENSIONS / BULBS

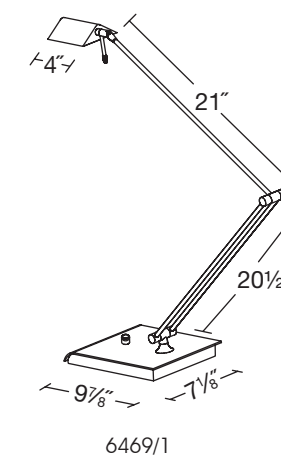

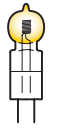
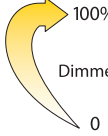
Halostar ECO 1x
 12V/50W - GY 6.35 IRC
 1180 Lumens
 3000 Kelvin

 100%
 Dimmer
 0
Manufactured by Osram GmbH
9250*050-HSTAR
 Equipped with a full-range, turn-knob dimmer.

RELATED ITEMS





6444 Halogen ECO/IRC
BERNIE SERIES

FINISH OPTIONS

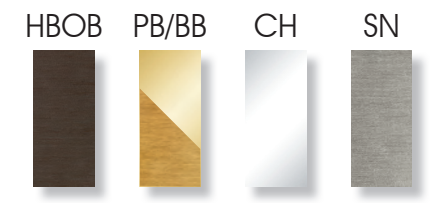

DIMENSIONS / BULBS

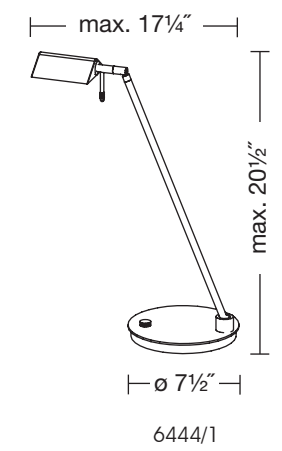

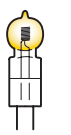
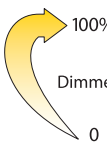
Halostar ECO 1x
 12V/50W - GY 6.35 IRC
 1180 Lumens
 3000 Kelvin

 100%
 Dimmer
 0
Manufactured by Osram GmbH
 9250*050-HSTAR
 Equipped with a full-range, turn-knob dimmer.

RELATED ITEMS





6477 CH



ECO/IRC Detail



LED Detail



Swivel Detail



Dimmer Detail

6477 Halogen ECO/IRC
6477*LED
BERNIE SERIES

FINISH OPTIONS

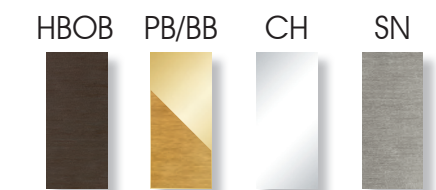

DIMENSIONS / BULBS

6477 ECO/IRC: Halostar ECO 1x
12V/60W - GY 6.35 IRC
1650 Lumens
3000 Kelvin
Manufactured by Osram GmbH
9250*060-HSTAR
Equipped with a full-range, turn-knob dimmer.

6477/1 & 6477/8*LED

LED SPECIFICATIONS

- Light Engine:** Holtkötter PC Board LED 11-8 with 8x CREE XP-G LEDs
- Optic / Reflector:** Holtkötter Aluminum Reflector \varnothing 134x100 with 60° x 5mm Optics
- Light Output:** 1120 Lumens, equivalent to 80W Halogen
- Light Color:** 2900 Kelvin
- Control/LED Driver/Dimmer:** Holtkötter Dimm-System LED with full-range dimming of < 1% - 100%
- Maximum Current/Voltage:** 1000mA & 14V
- System Power Consumption:** 2...14 Watt



FINISH OPTIONS

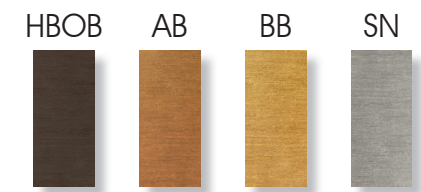

DIMENSIONS / BULBS

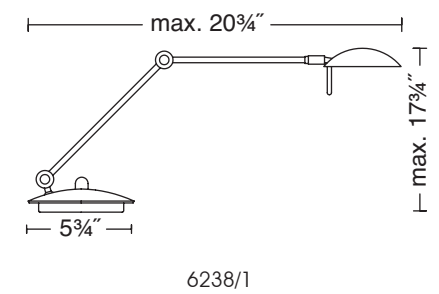

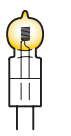
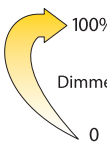

Halostar ECO 1x
 12V/35W - GY6.35 IRC
 860 Lumens
 2900 Kelvin

 100%
 Dimmer
 0
Manufactured by Osram GmbH
 9250*035-HSTAR
 Equipped with a full-range, turn-knob dimmer.

RELATED ITEMS



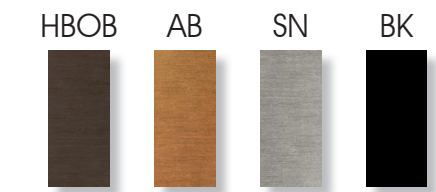

FINISH OPTIONS



DIMENSIONS / BULBS

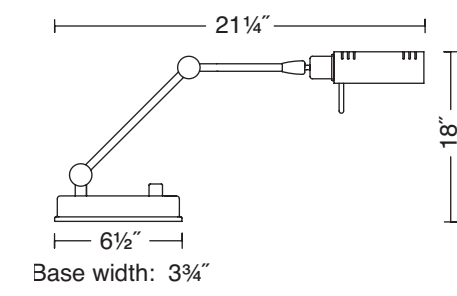

8346/1

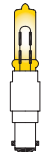
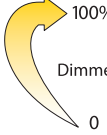
Halolux® Ceram 1x
 120V/100W - B15d Clear
 1500 Lumens
 2900 Kelvin
 Manufactured by Osram GmbH

 100%
 Dimmer
 0
9250*100-DC/CL
 Equipped with a full-range, turn-knob dimmer.

RELATED ITEMS





6506 SN MGR (l)
6506 SN PBL (r)

FINISH OPTIONS

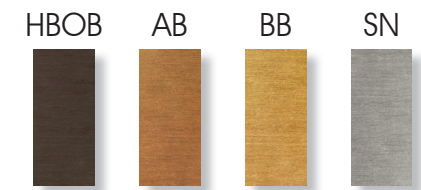

GLASS OPTIONS

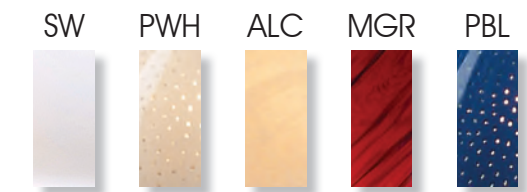

DIMENSIONS / BULBS

Halopin® 1x
120V/60W - G9 Clear

800 Lumens
2900 Kelvin

Manufactured by Osram GmbH

9250*060-HPNCL
Equipped with an on/off switch.

6506/1

RELATED ITEMS

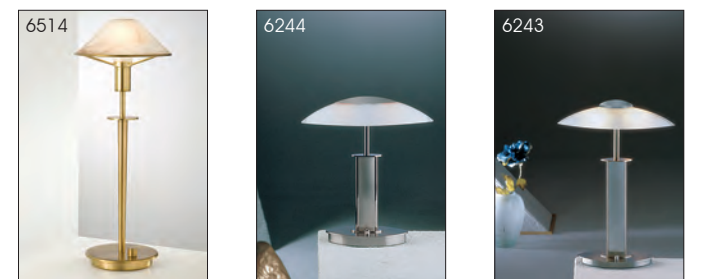



6504 CH



6514 HBOB ABR

6504
6514
LIGHTING FOR THE AGING EYE

FINISH OPTIONS

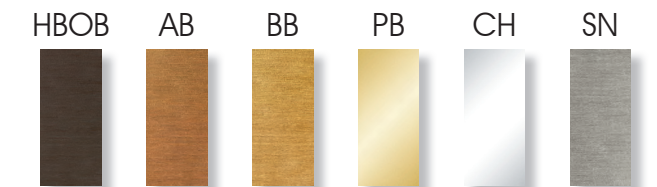

GLASS OPTIONS



When ordering, please indicate a glass choice for item No. 6514.

DIMENSIONS / BULBS

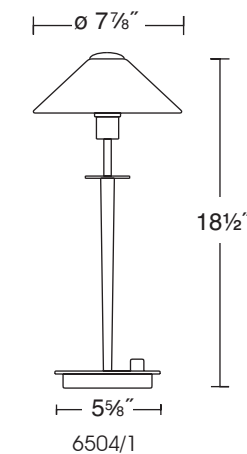

6504/1

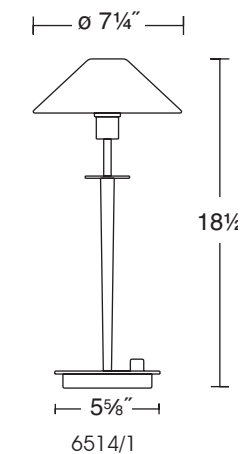

6514/1

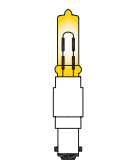

Halolux® Ceram 1x
120V/100W - B15d Clear

1500 Lumens
2900 Kelvin

Manufactured by Osram GmbH

9250*100-DC/CL

Equipped with a full-range, turn-knob dimmer.
Item 6504/1 in Chrome is supplied with 1x 75W
Halolux® Ceram bulb.

RELATED ITEMS



9424/9434



6505 & 6515

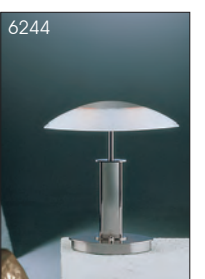

6244



6244 HBOB CHA

FINISH OPTIONS

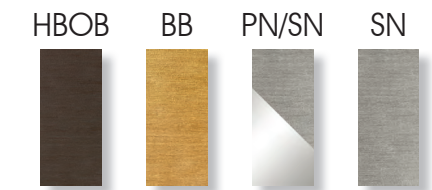

GLASS OPTIONS

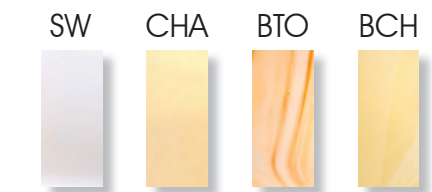

DIMENSIONS / BULBS

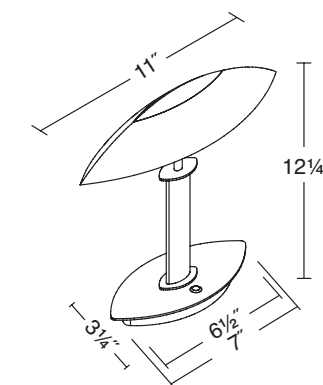

6244/2

Halopin® 2x
120V/40W - G9 Clear
490 Lumens per bulb (Σ 980)
2700 Kelvin
Manufactured by Osram GmbH
9250*040-HPNCL
Equipped with a full-range, turn-knob dimmer.

RELATED ITEMS

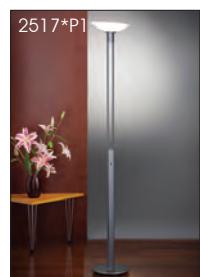



FINISH OPTIONS

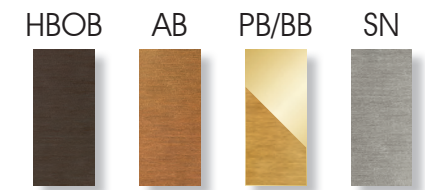



GLASS OPTIONS

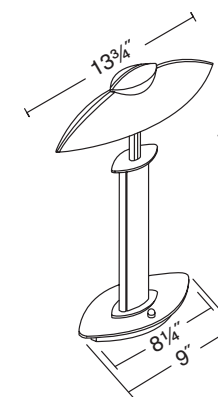

DIMENSIONS / BULBS



6243/2

Krypton/Xenon 2x
 120V/60W - G9 Clear
 800 Lumens per bulb (Σ 1600)
 2900 Kelvin

 100% Dimmer
 0
Manufactured by Osram GmbH
9250*060-HPNCL
 Equipped with a full-range, turn-knob dimmer.

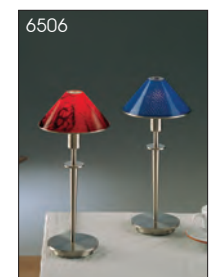
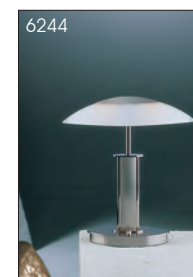
RELATED ITEMS





6263 HBOB KPNR

FINISH OPTIONS

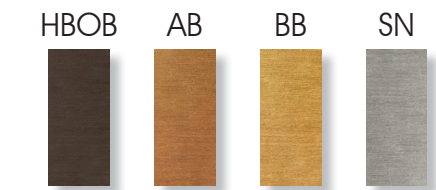

SHADE OPTIONS



DIMENSIONS / BULBS

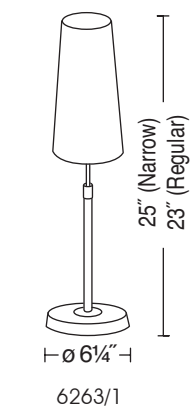

120V/max. 100W* 1x
Medium Base, not included.

Shade Dimensions:	Narrow	Regular
Shade Top ø	4½"	9"
Shade Bottom ø	6"	12"
Shade Height	11¼"	9"

Equipped with a low/high/off switch.

In order to comply with the laws in the State of California, all shipments of this lamp to the State of California include a compact fluorescent light bulb.

*To preserve the color integrity of the narrow shades, use up to 75W max. or Low UV bulbs.

RELATED ITEMS





6031 SN SW SWSQ (l)
6032 SN SW SWSQ (r)

6031
6032
GALILEO SERIES

FINISH OPTIONS

SN



SHADE OPTIONS

SWRD



SWSQ



DIMENSIONS / BULBS

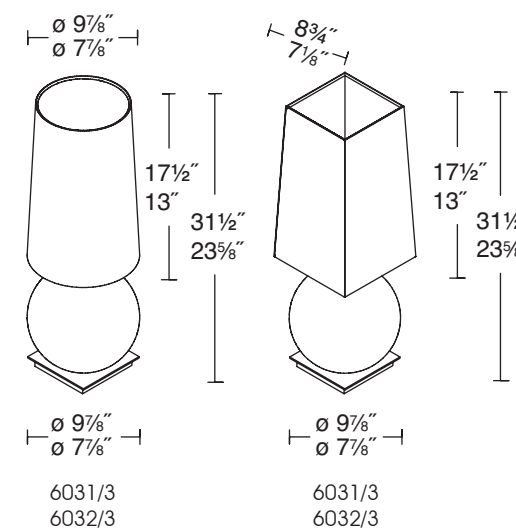

Shade: 120V/max. 150W
3-Way : 50W/100W/150W
Medium Base, not included.

1x



Glass Base: Osram Halopin® G9, Frosted
6031: 120V/max. 40W, 460 Lumens per bulb (Σ 920)
6032: 120V/max. 25W, 260 Lumens per bulb (Σ 520)

2x

Manufactured by Osram GmbH



9250*0(25)(40)-HPNFR

In order to comply with the laws in the State of California, all shipments of this lamp to the State of California include a compact fluorescent light bulb.

Equipped with a full-range, turn-knob dimmer for the base and a three-way switch for the shade.

RELATED ITEMS





VOLKSLAMPE ●



VL100 VOLKSLAMPE

FINISH OPTIONS



SHADE OPTIONS



DIMENSIONS / BULBS

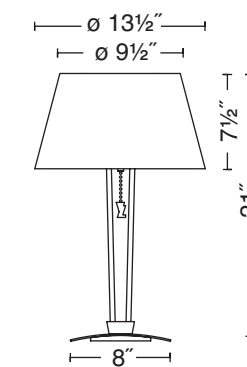

VL100

 Compact Fluorescent -
Energy Star 2x
120V/18W - GU24

1200 Lumens per bulb (Σ 2400)
2700 Kelvin

9250*018-GU24

Equipped with a three-way, pull-chain switch.

RELATED ITEMS



VL100 SN KPRG



VL200 VOLKSLAMPE

FINISH OPTIONS

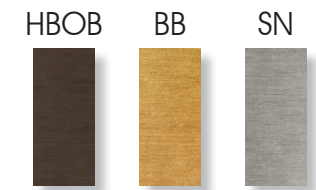

SHADE OPTIONS



DIMENSIONS / BULBS

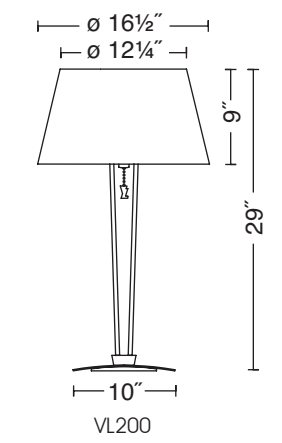

 Compact Fluorescent - Energy Star 3x
120V/18W - GU24

1200 Lumens per bulb (Σ 3600)
2700 Kelvin

9250*018-GU24
Equipped with a three-way, pull-chain switch.

RELATED ITEMS





VL300 BB KPRG



VL300
VOLKSLAMPE

FINISH OPTIONS



SHADE OPTIONS

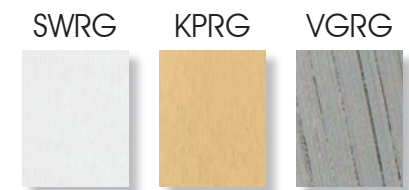

DIMENSIONS / BULBS

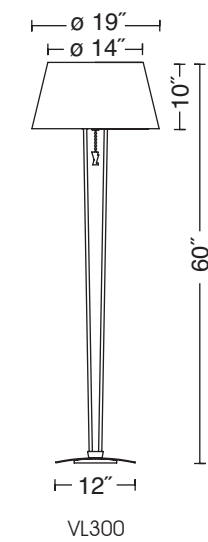

 Compact Fluorescent - Energy Star 3x
120V/23W - GU24

1600 Lumens per bulb (Σ 4800)
2700 Kelvin

9250*023-GU24

Equipped with a three-way, pull-chain switch.

RELATED ITEMS

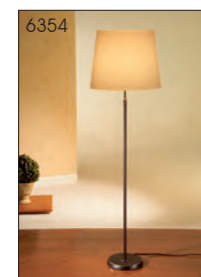



VL500 SN KPRG



VL500 SN SWRG



VL500
VOLKSLAMPE

FINISH OPTIONS



SHADE OPTIONS

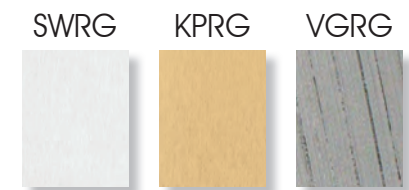

DIMENSIONS / BULBS

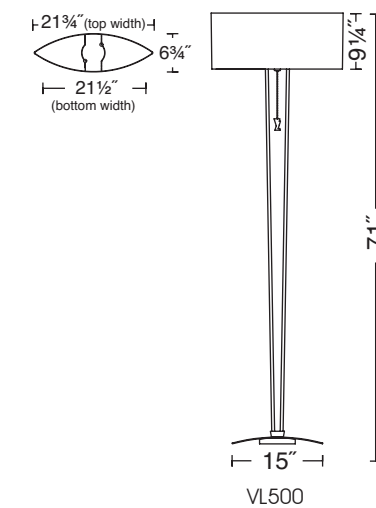

Compact Fluorescent - Energy Star 3x
120V/27W - GU24
1800 Lumens per bulb (Σ 5400)
2700 Kelvin
9250*027-GU24
Equipped with a three-way, pull-chain switch.

RELATED ITEMS



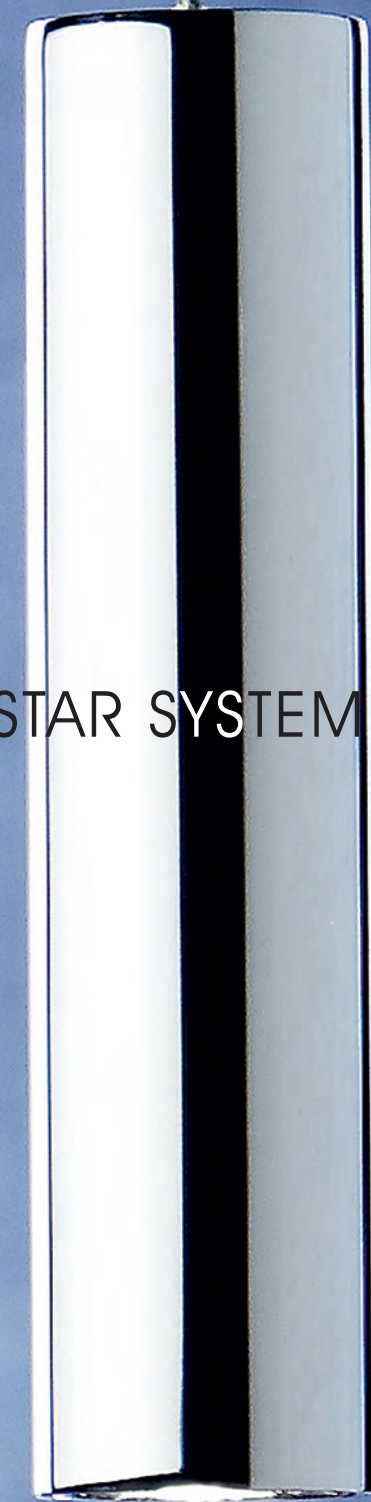
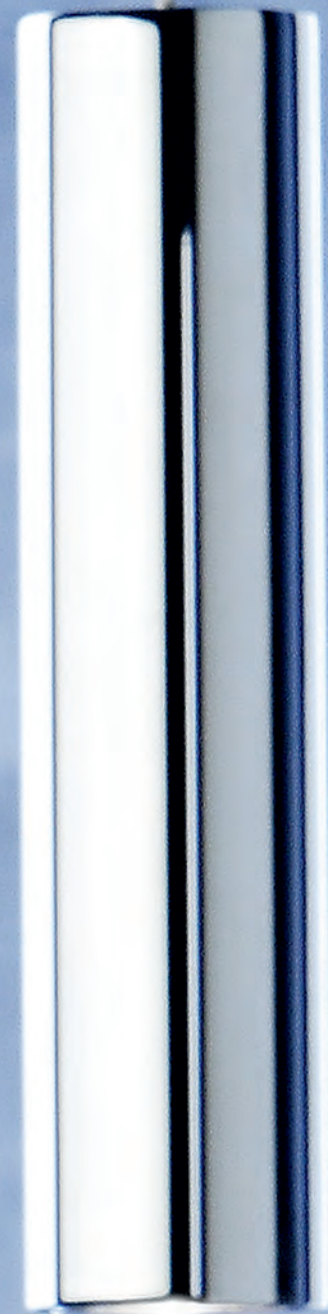

LICHTSTAR SYSTEM

LICHTSTAR LED PENDANT
ADJUSTABLE TRIPLE CANOPY

- C-9750
- R-9731*LED
- R-9732*LED
- R-9733*LED with Glass
- R-9734*LED

FINISH OPTIONS

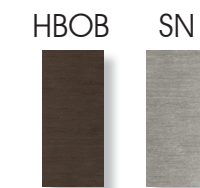

Finish Options listed are for Canopy C-9750.
For complete ordering information, please refer to pages 130-131.

LED SPECIFICATIONS

- Light Engine:** Citizen 13.5 mm COB Series LED
- Optic / Reflector:** Holtkötter
- Light Output:** 440 Lumens
- Light Color:** 2900 Kelvin
- Control/LED Driver/Dimmer:** Holtkötter 12V Dimmable LED Driver requires an ELV dimmer for perfect dimming
- Maximum Current/Voltage:** 350mA & 12V
- System Power Consumption:** 4.2 Watts

LED reflectors include a Suspension Kit with Quick Connect and 6 feet of coaxial cable.
When ordering R-9733*LED, please choose a glass option to accompany it.
For complete ordering information, please refer to pages 130-131.

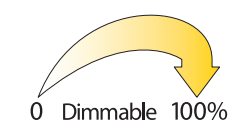

DIMENSIONS

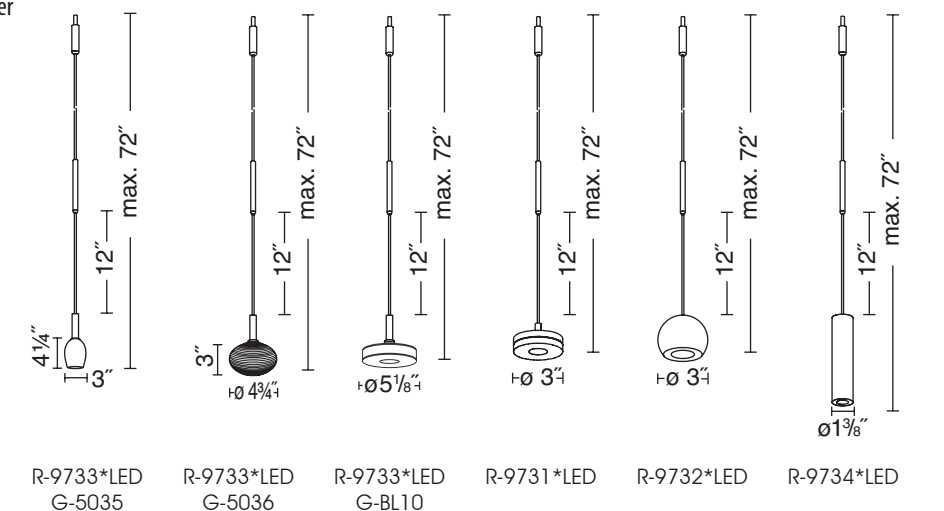
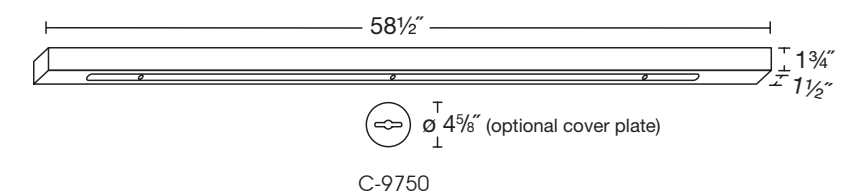

C9750 R9733*LED GBL10 SN

LICHTSTAR HALOGEN PENDANT
ADJUSTABLE TRIPLE CANOPY

C-9750
FABRIC SHADE
GLASS



FABRIC SHADE OPTIONS

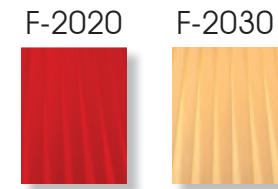

FINISH OPTIONS

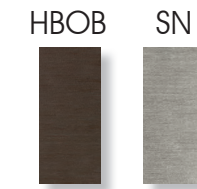

Finish Options listed are for Canopy C-9750.
For complete ordering information, please refer to pages 130-131.

GLASS OPTIONS



DIMENSIONS / BULBS

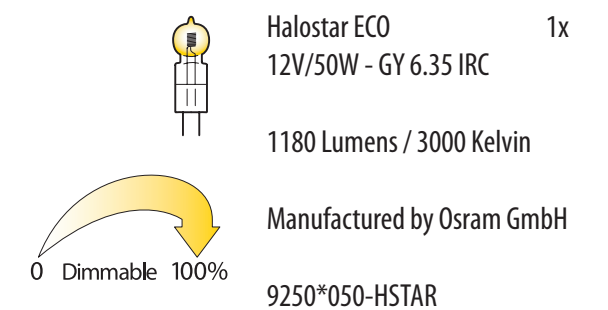

All fabric shades and glass options include a Suspension Kit with Quick Connect and 6 feet of coaxial cable.
For complete ordering information, please refer to pages 130-131.

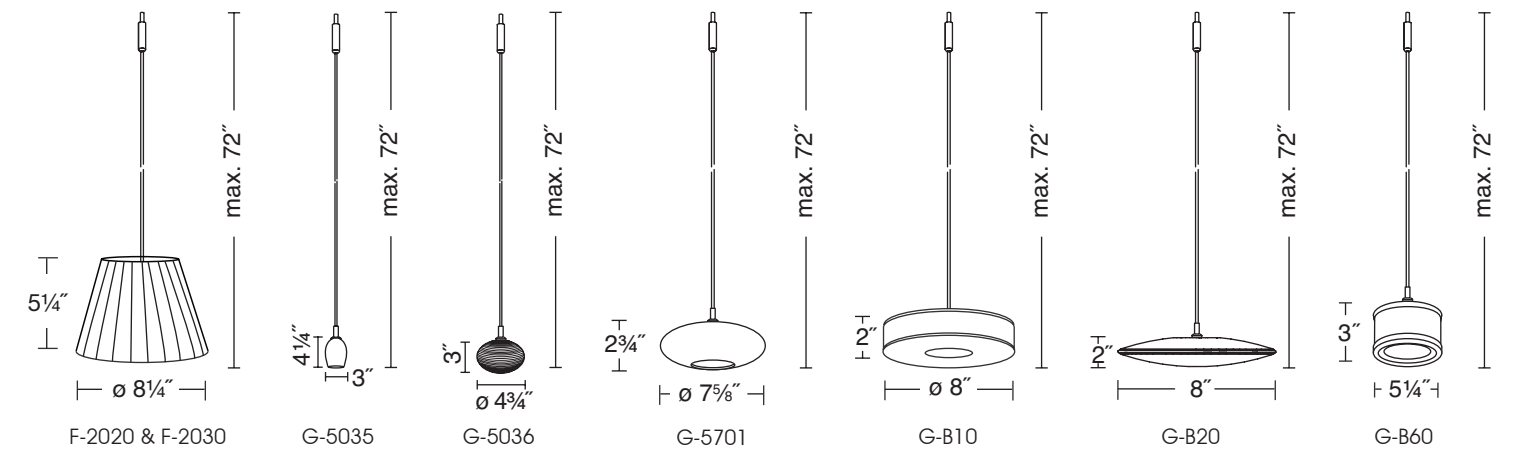
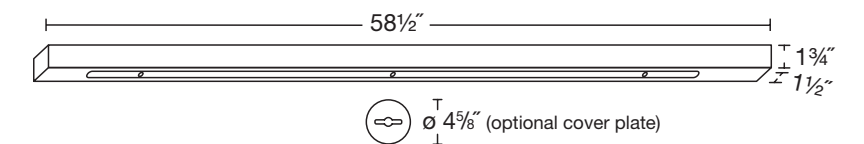

LICHTSTAR LED PENDANT
SINGLE CANOPY



R-9731*LED CH



R-9732*LED CH



R-9734*LED CH

- C-8110 & C-8120
- R-9731*LED
- R-9732*LED
- R-9734*LED

FINISH OPTIONS

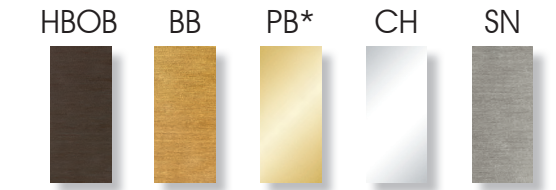

*Canopy C-8110 & C-8120 only.
For complete ordering information, please refer to pages 130-131.

DIMENSIONS

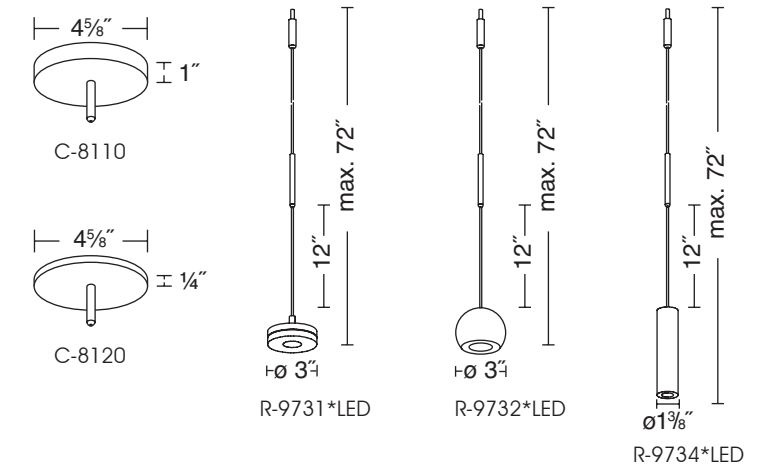

LED SPECIFICATIONS

Light Engine:	Citizen 13.5mm COB Series LED
Optic / Reflector:	Holtkötter
Light Output:	440 Lumens
Light Color:	2900 Kelvin
Control/LED Driver/Dimmer:	Holtkötter 12V Dimmable LED Driver requires an ELV dimmer for perfect dimming
Maximum Current/Voltage:	350mA & 12V
System Power Consumption:	4.2 Watts

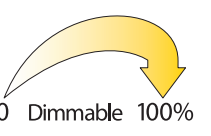

LED reflectors include a Suspension Kit with Quick Connect and 6 feet of coaxial cable.
For complete ordering information, please refer to pages 130-131.



LICHTSTAR LED PENDANT
SINGLE CANOPY

C-8110 & C-8120
R-9733*LED
GLASS

FINISH OPTIONS

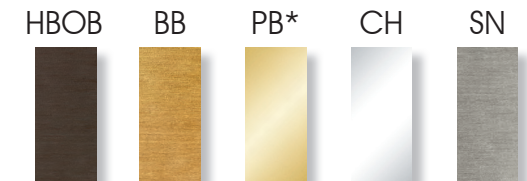

*Canopy C-8110 & C-8120 only.
For complete ordering information, please refer to pages 130-131.

GLASS OPTIONS



DIMENSIONS

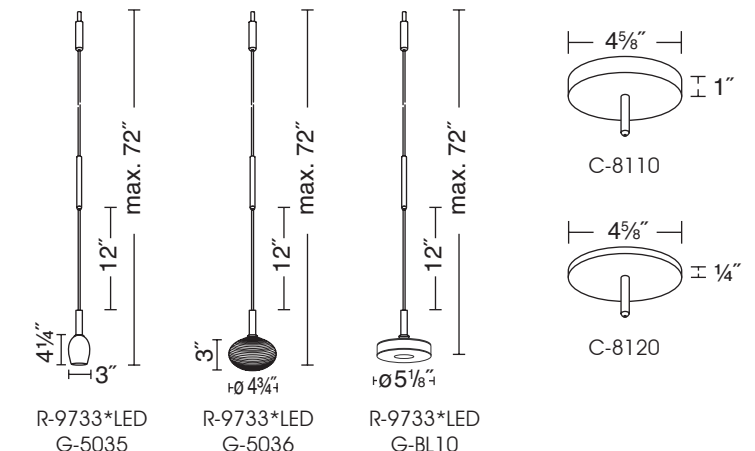

LED SPECIFICATIONS

Light Engine:	Citizen 13.5mm COB Series LED
Optic / Reflector:	Holtkötter
Light Output:	440 Lumens
Light Color:	2900 Kelvin
Control/LED Driver/Dimmer:	Holtkötter 12V Dimmable LED Driver requires an ELV dimmer for perfect dimming
Maximum Current/Voltage:	350mA & 12V
System Power Consumption:	4.2 Watts

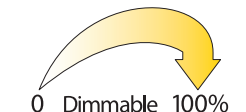

LED reflectors include a Suspension Kit with Quick Connect and 6 feet of coaxial cable.
For complete ordering information, please refer to pages 130-131.



R-9733*LED G-5035 HBOB



R-9733*LED G-5036 CH



C8110 S006 F2030 HBOB



C-8110 F-2020 HBOB

LICHTSTAR HALOGEN PENDANT
SINGLE CANOPY

C-8110 & C-8120
FABRIC SHADE

FINISH OPTIONS

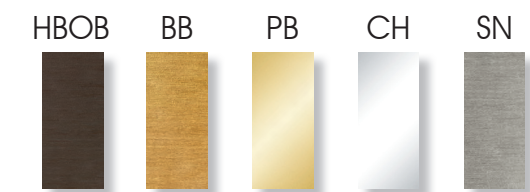

SHADE OPTIONS

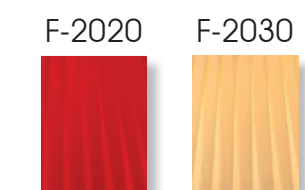

Shade options include a Suspension Kit with Quick Connect and 6 feet of coaxial cable. For complete ordering information, please refer to pages 130-131.

DIMENSIONS / BULBS

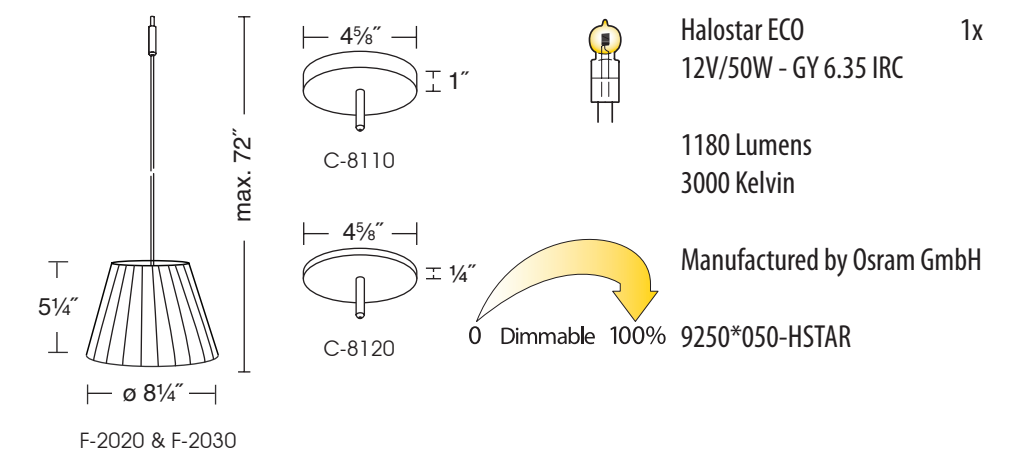

C-8110 & C-8120
GLASS

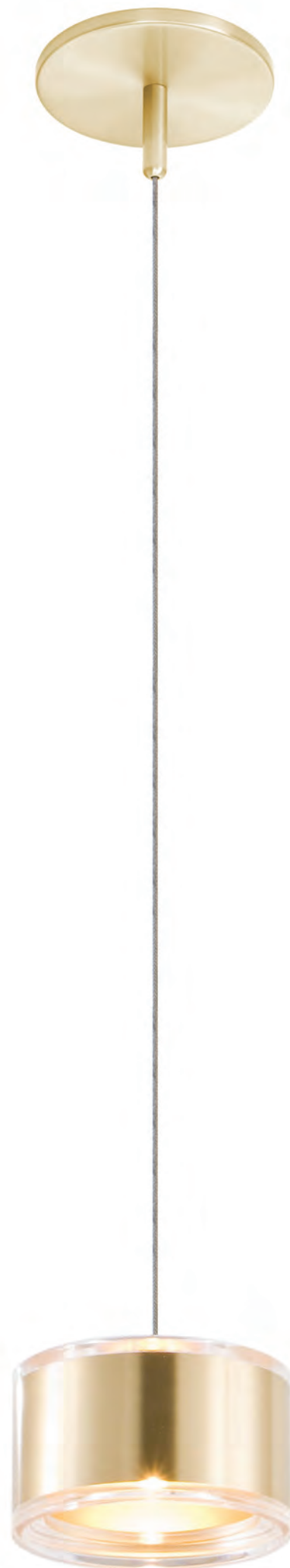

DIMENSIONS / BULBS

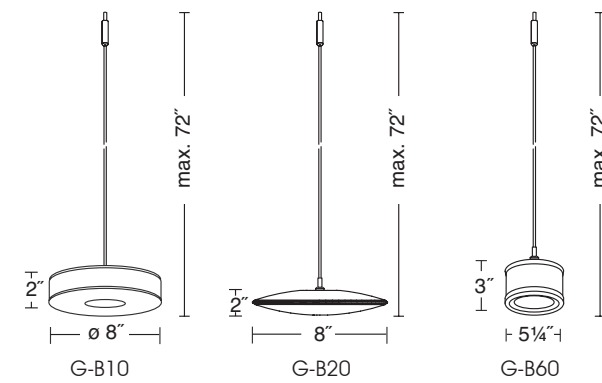
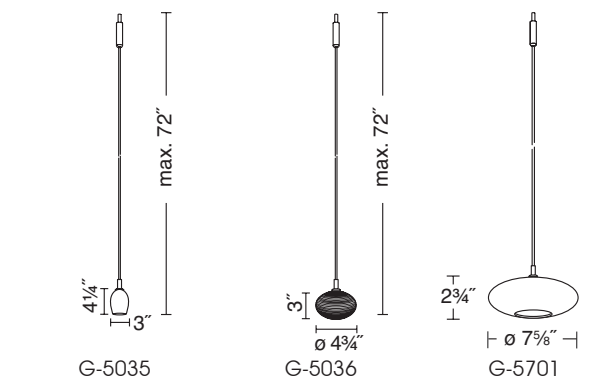
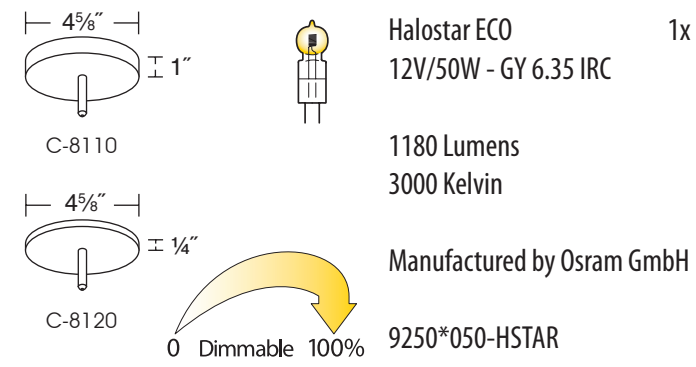

FINISH OPTIONS

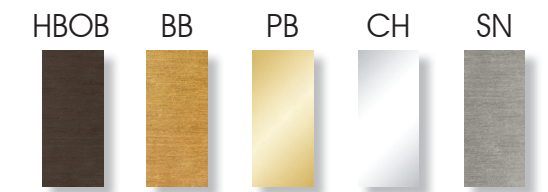

GLASS OPTIONS



All glass options include a Suspension Kit with Quick Connect and 6 feet of coaxial cable.
For complete ordering information, please refer to pages 130-131.

LICHTSTAR SPOTLIGHT
SINGLE CANOPY

C-8110 & C-8120
R-5900



C-8110 PB R-5900 BB



C-8110 R-5900 HOB

FINISH OPTIONS

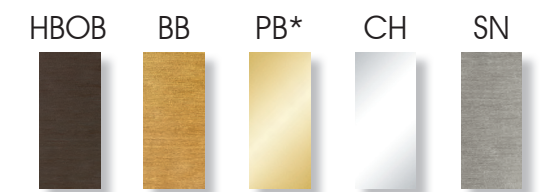

*Canopy C-8110 & C-8120 only.
For complete ordering information, please refer to pages 130-131.

DIMENSIONS / BULBS

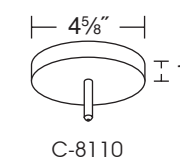

C-8110

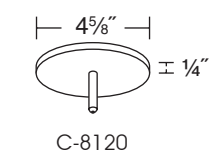

C-8120



Decostar® 51 ALU
12V/35W - GU 5.3 - 36°

1x

1100 Candela**
2900 Kelvin

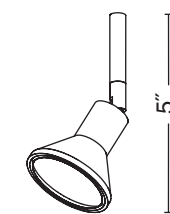

R-5900

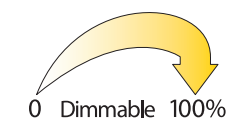

Manufactured by Osram GmbH

9250*035-SPOT

** Luminous intensity in a given direction

RELATED ITEMS



C-8410 R-5900



C-8310 R-5900

LICHTSTAR NOTE
SINGLE CANOPY

C-8110 & C-8120
G-5770 "NOTE" GLASS



C8120 G5770 SN



C-8110 G-5770 PB

FINISH OPTIONS

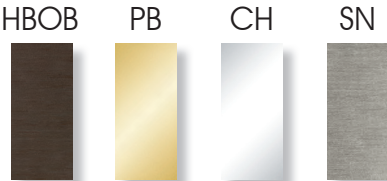

DIMENSIONS / BULBS

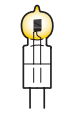
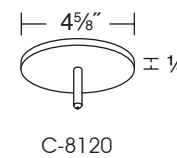
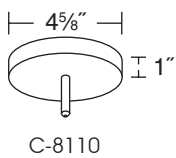

Halostar ECO 1x
12V/35W - GY 6.35 IRC

860 Lumens
2900 Kelvin

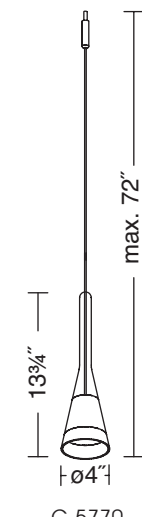

0 Dimmable 100%

Manufactured by Osram GmbH

9250*035-HSTAR

G-5770 includes Suspension with Quick Connect and 5 feet of coaxial cable.

The glass shade can be released from the cable for easy cleaning.

For complete ordering information, please refer to pages 130-131.



C8410 G5770 SN

LICHTSTAR NOTE
TRIPLE OR QUAD CANOPY

C-8310 & C-8410
G-5770 "NOTE" GLASS



C-8310 G-5770 HBOB

FINISH OPTIONS

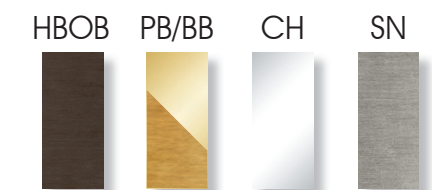

PB/BB: C-8310 BB with G-5770 PB or C-8410 BB with G-5770 PB.

DIMENSIONS / BULBS

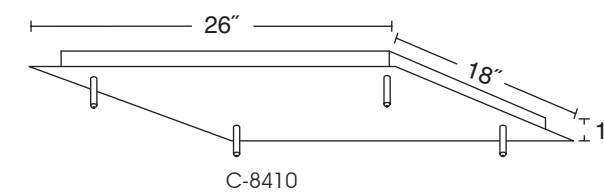
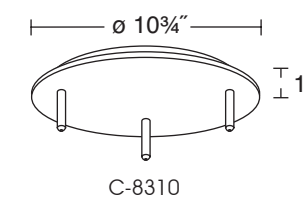

Halostar ECO 1x
12V/35W - GY 6.35 IRC

860 Lumens
2900 Kelvin

Manufactured by Osram GmbH
9250*035-HSTAR

0 Dimmable 100%

G-5770 includes Suspension with Quick Connect and 5 feet of coaxial cable.

The glass shade can be released from the cable for easy cleaning.

For complete ordering information, please refer to pages 130-131.

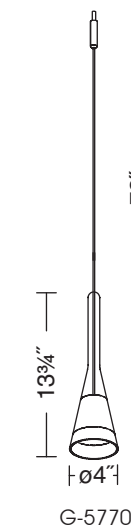



C8310 R5900 SN

LICHTSTAR SPOTLIGHT
TRIPLE or QUAD CANOPY

C-8310 & C-8410
R-5900



C-8410 R-5900 BB

FINISH OPTIONS

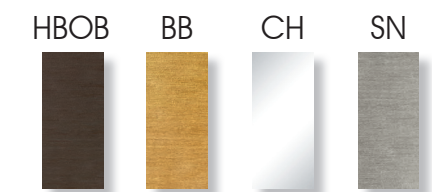

For complete ordering information, please refer to pages 130-131.

DIMENSIONS / BULBS

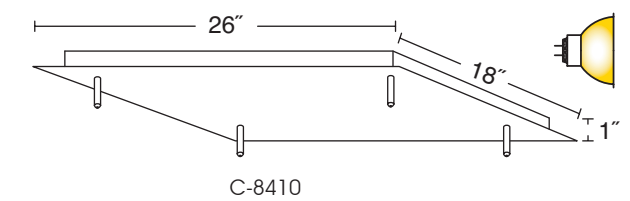
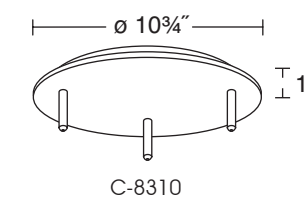

Decostar® 51 ALU 1x
12V/35W - GU 5.3 - 36°

1100 Candela**
2900 Kelvin

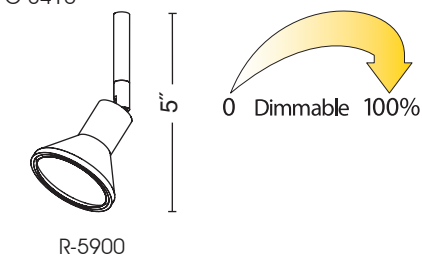

Manufactured by Osram GmbH
9250*035-SPOT

** Luminous intensity in a given direction

RELATED ITEMS



LICHTSTAR LED PENDANT
TRIPLE CANOPY

C-8310
R-9731*LED
R-9732*LED
R-9734*LED

FINISH OPTIONS

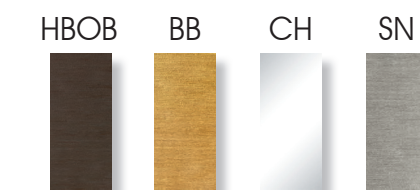

For complete ordering information, please refer to pages 130-131.

DIMENSIONS

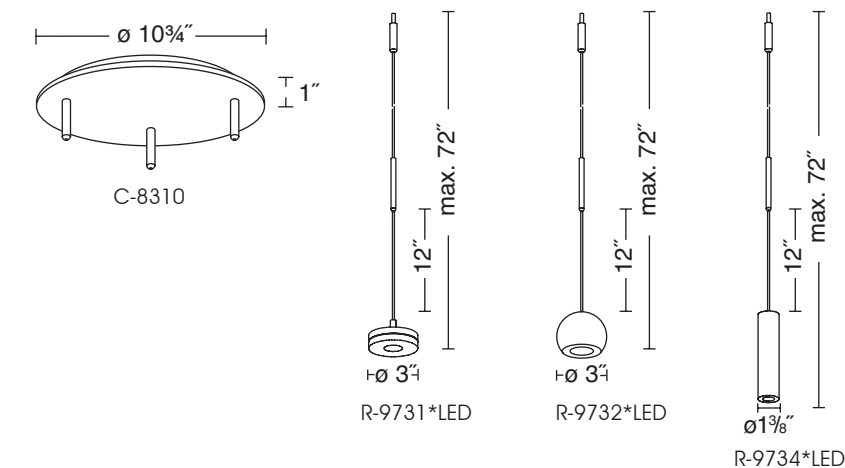

LED SPECIFICATIONS

Light Engine:	Citizen 13.5mm COB Series LED
Optic / Reflector:	Holtkötter
Light Output:	440 Lumens
Light Color:	2900 Kelvin
Control/LED Driver/Dimmer:	Holtkötter 12V Dimmable LED Driver requires an ELV dimmer for perfect dimming
Maximum Current/Voltage:	350mA & 12V
System Power Consumption:	4.2 Watts

LED reflectors include a Suspension Kit with Quick Connect and 6 feet of coaxial cable.
For complete ordering information, please refer to pages 130-131.

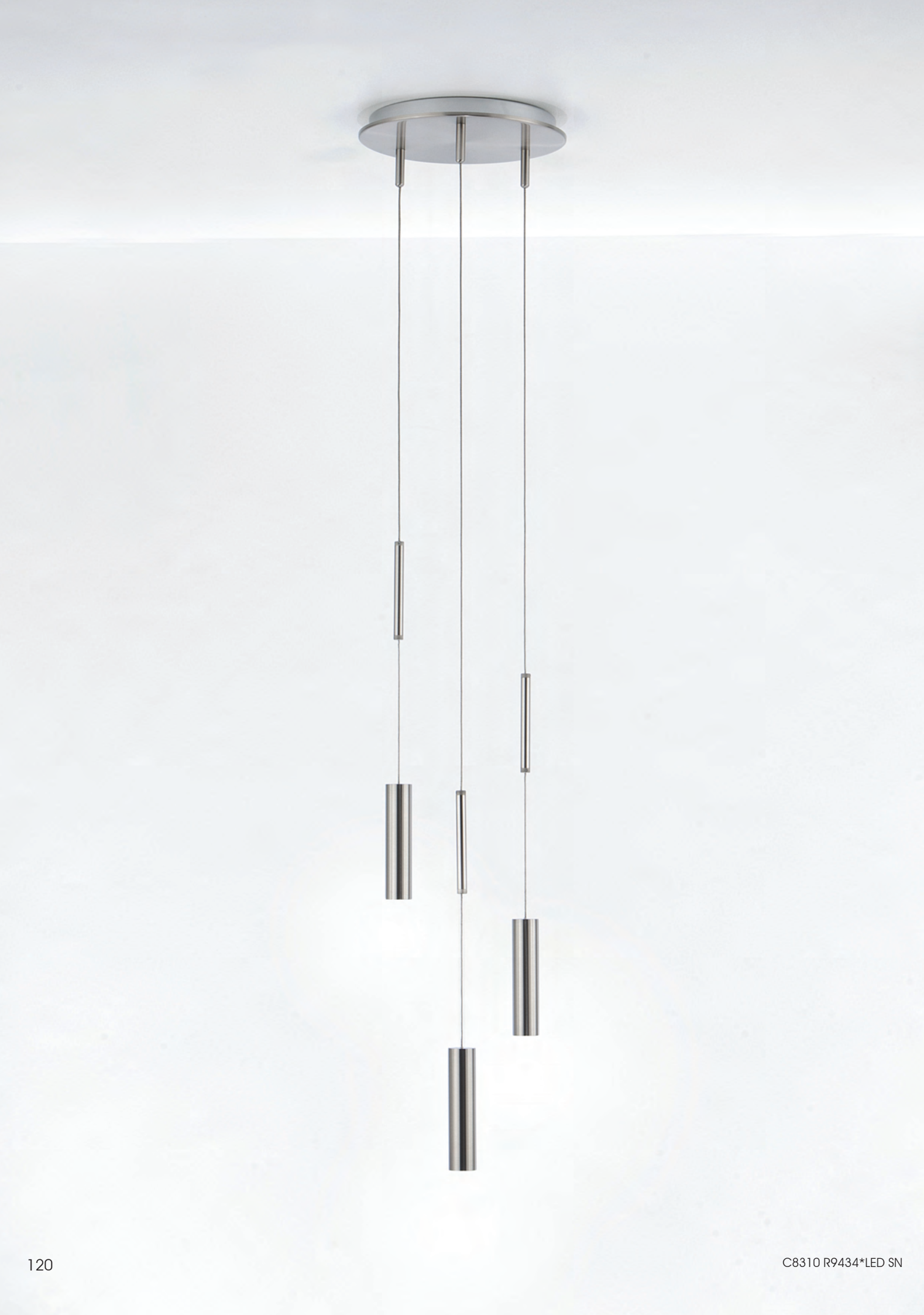

R-9731*LED CH



R-9732*LED CH



R-9734*LED CH

LICHTSTAR HALOGEN PENDANT
TRIPLE CANOPY

C-8310
FABRIC SHADE
GLASS



FABRIC SHADE OPTIONS

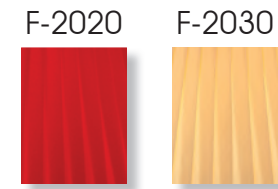

FINISH OPTIONS

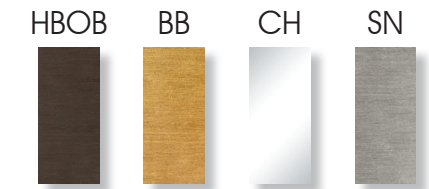

GLASS OPTIONS



DIMENSIONS / BULBS

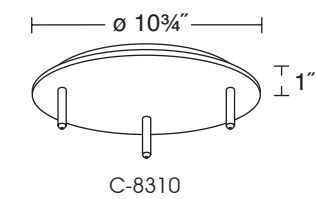
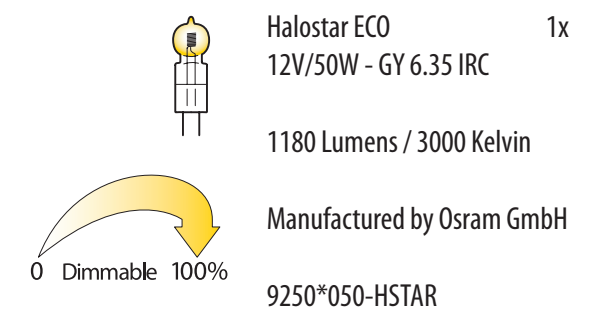

All fabric shades and glass options include a Suspension Kit with Quick Connect and 6 feet of coaxial cable.
For complete ordering information, please refer to pages 130-131.

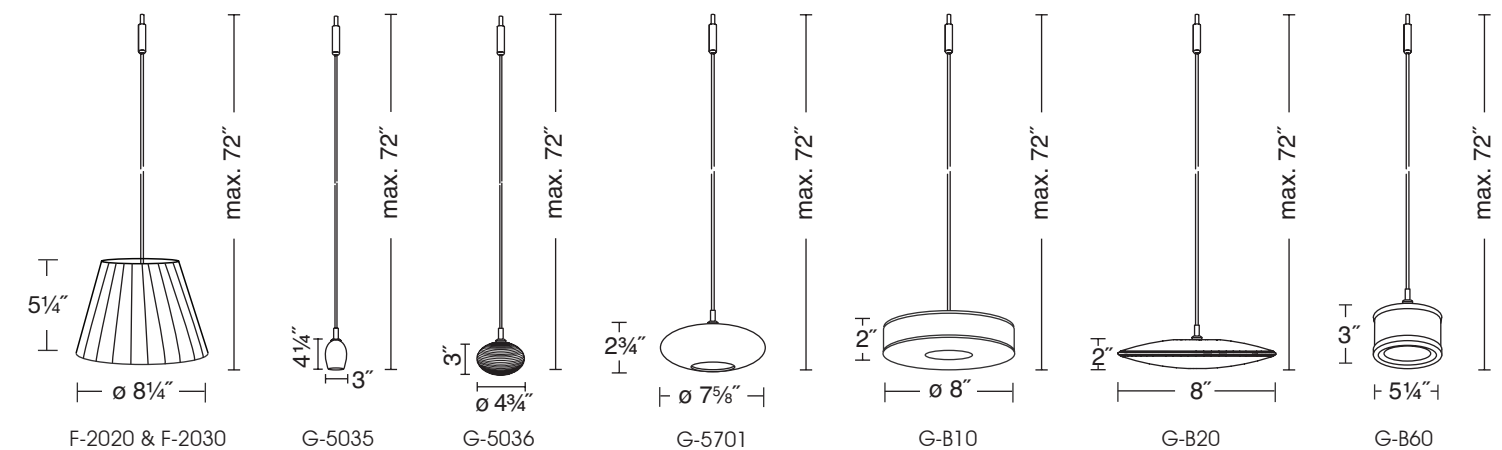

LICHTSTAR LED PENDANT
QUAD CANOPY

- C-8410
- R-9731*LED
- R-9732*LED
- R-9734*LED

FINISH OPTIONS

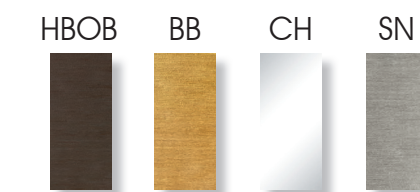

For complete ordering information, please refer to pages 130-131.

DIMENSIONS

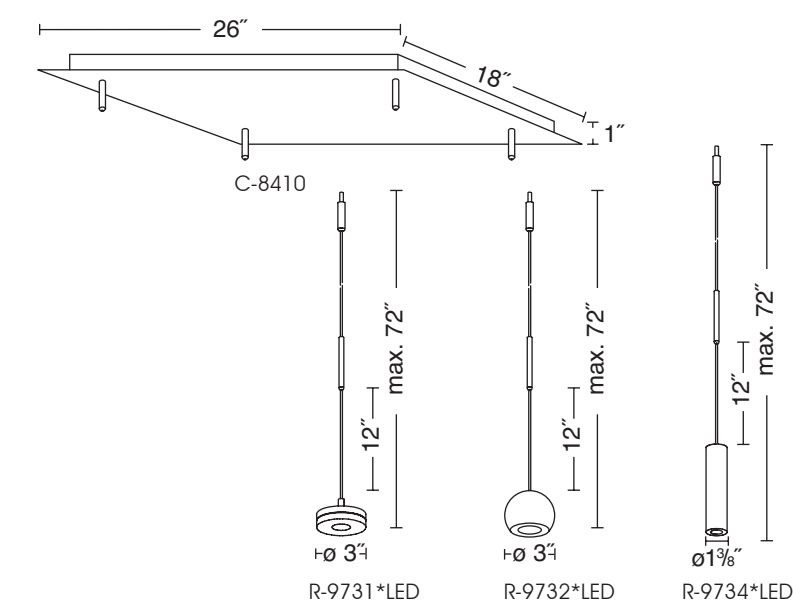

LED SPECIFICATIONS

Light Engine:	Citizen 13.5mm COB Series LED
Optic / Reflector:	Holtkötter
Light Output:	440 Lumens
Light Color:	2900 Kelvin 0 Dimmable 100%
Control/LED Driver/Dimmer:	Holtkötter 12V Dimmable LED Driver requires an ELV dimmer for perfect dimming
Maximum Current/Voltage:	350mA & 12V
System Power Consumption:	4.2 Watts

LED reflectors include a Suspension Kit with Quick Connect and 6 feet of coaxial cable.
For complete ordering information, please refer to pages 130-131.

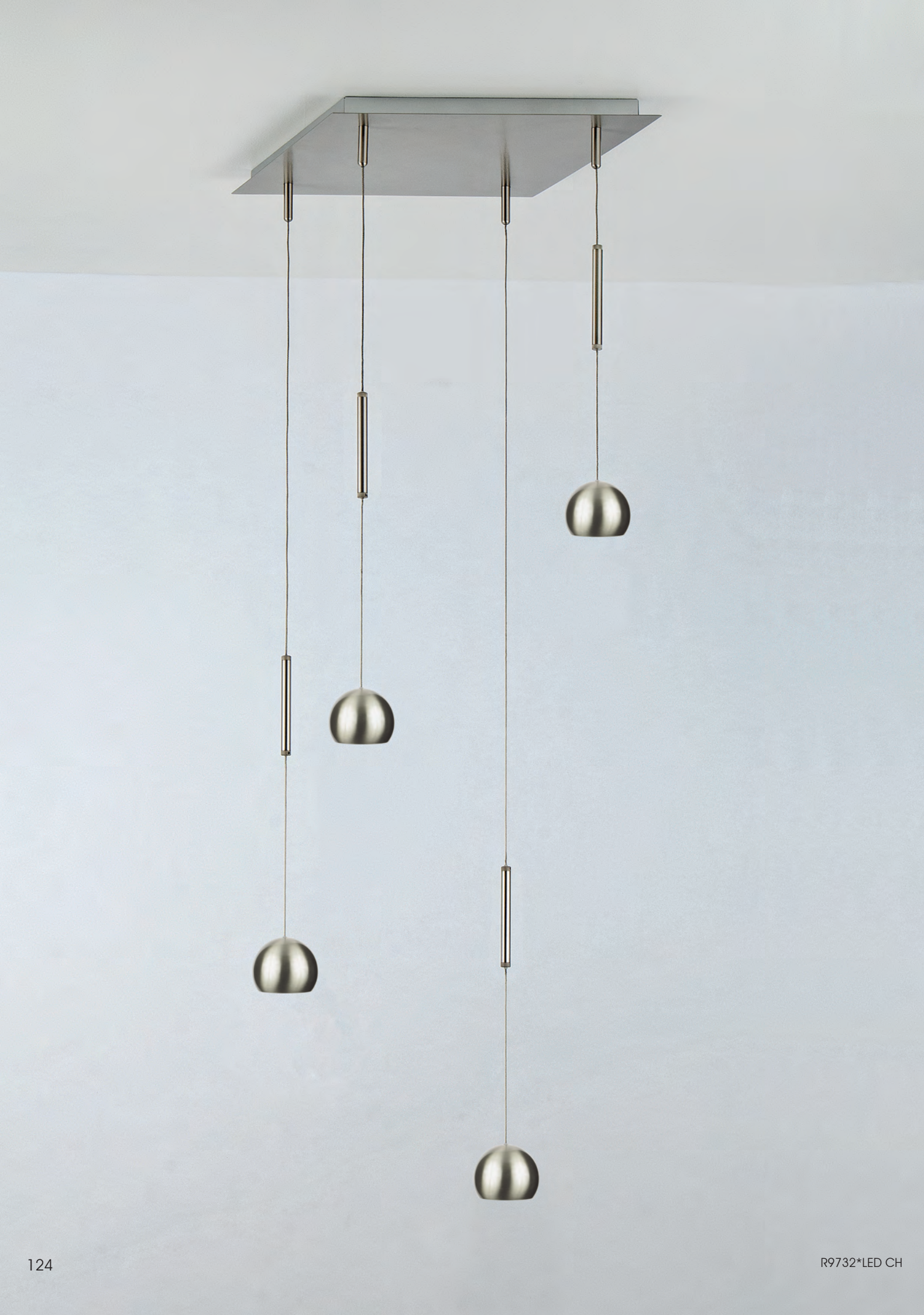

R-9731*LED CH



R-9732*LED CH



R-9734*LED CH

LICHTSTAR HALOGEN PENDANT
QUAD CANOPY

C-8410
FABRIC SHADE
GLASS



FABRIC SHADE OPTIONS

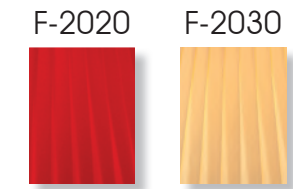

FINISH OPTIONS

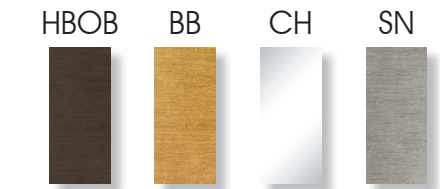

GLASS OPTIONS



DIMENSIONS / BULBS

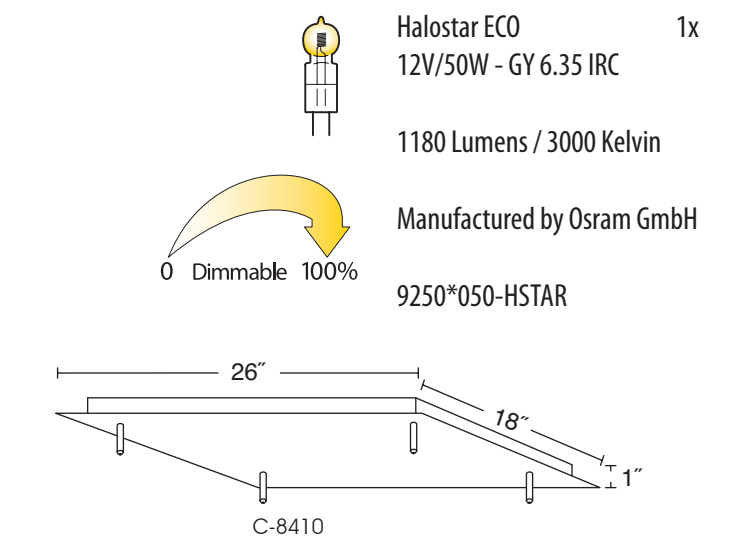

All fabric shades and glass options include a Suspension Kit with Quick Connect and 6 feet of coaxial cable.
For complete ordering information, please refer to pages 130-131.

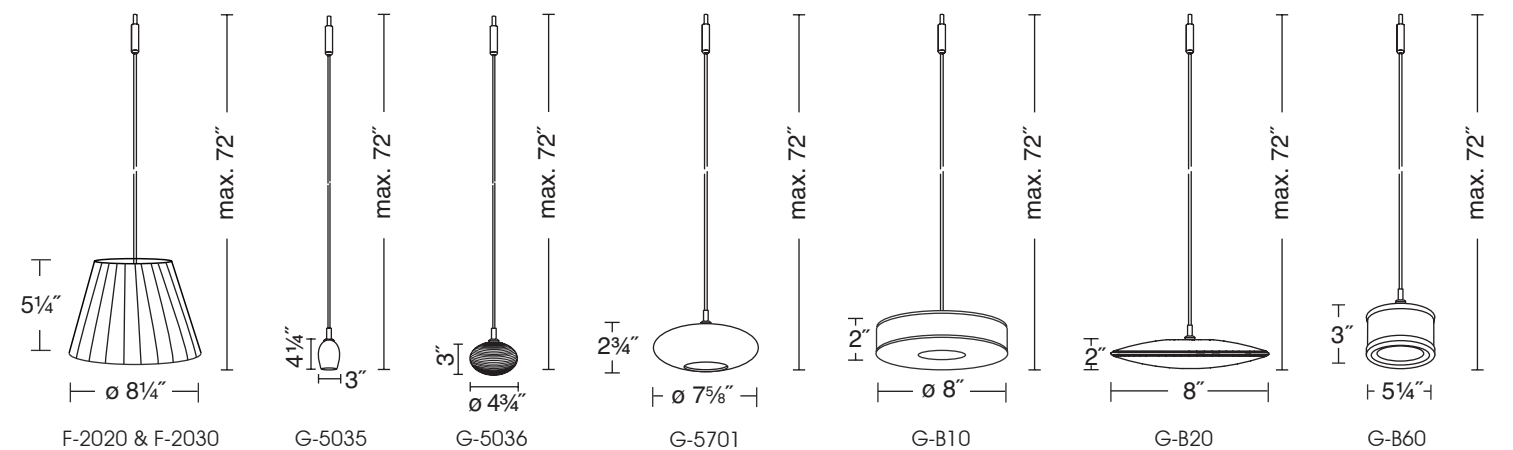



C8410 R9733*LED G5036 SN

LICHTSTAR LED PENDANT TRIPLE OR QUAD CANOPY

C-8310 & C-8410
R-9733*LED
GLASS

FINISH OPTIONS

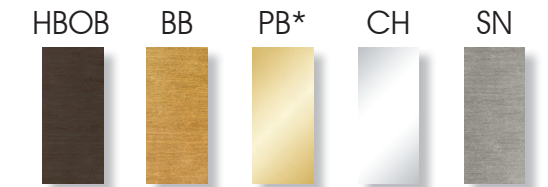

*Canopy C-8110 & C-8120 only.
For complete ordering information, please refer to pages 130-131.

GLASS OPTIONS



DIMENSIONS

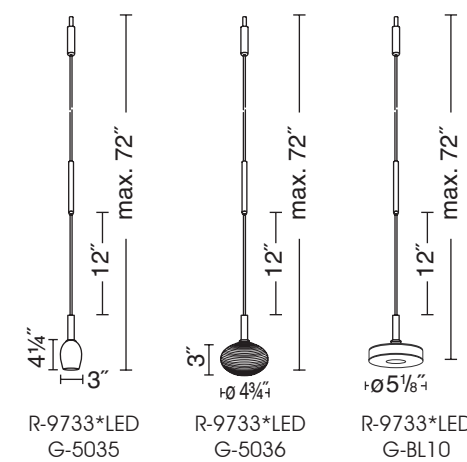

R-9733*LED G-5035 HBOB

R-9733*LED G-5036 CH

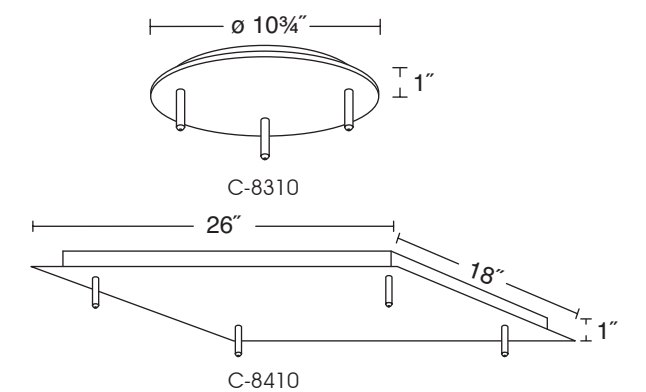

LED SPECIFICATIONS

Light Engine:	Citizen 13.5mm COB Series LED
Optic / Reflector:	Holtkötter
Light Output:	440 Lumens
Light Color:	2900 Kelvin
Control/LED Driver/Dimmer:	Holtkötter 12V Dimmable LED Driver requires an ELV dimmer for perfect dimming
Maximum Current/Voltage:	350mA & 12V
System Power Consumption:	4.2 Watts

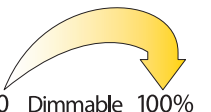

LED reflectors include a Suspension Kit with Quick Connect and 6 feet of coaxial cable.
For complete ordering information, please refer to pages 130-131.

LICHTSTAR SYSTEM ORDERING INFORMATION

- 1) Choose a **canopy** and indicate the finish option.
- 2) Choose a **reflector** and indicate the finish option **OR** choose a combination of **suspension and glass** and indicate the finish option(s).

CANOPY OPTIONS

LICHTSTAR BAR CANOPY WITH 3 MOVABLE PENDANT LOCATIONS (58½" X 1½" X 1¾")

C-9750

C-9750 HB/OB
C-9750 SN

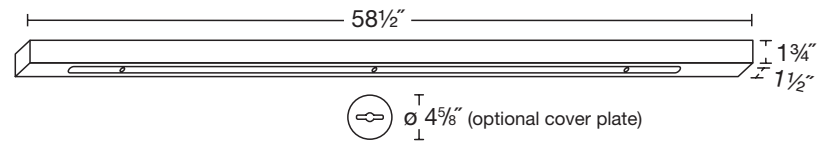

LICHTSTAR SINGLE CANOPY, ROUND (ø4 5/8" X 1")

C-8110

C-8110 BB
C-8110 CHROME
C-8110 HB/OB
C-8110 PB
C-8110 SN

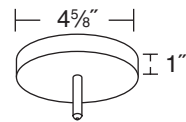

LICHTSTAR TRIPLE CANOPY, ROUND (ø10 3/4" X 1")

C-8310

C-8310 BB
C-8310 CHROME
C-8310 HB/OB
C-8310 SN

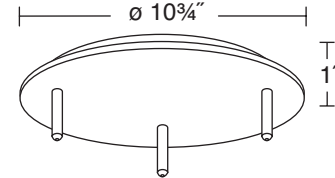

LICHTSTAR SINGLE CANOPY, ROUND (ø4 5/8" X 1/4")

C-8120

C-8120 BB
C-8120 CHROME
C-8120 HB/OB
C-8120 PB
C-8120 SN

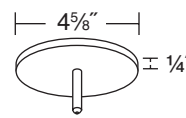

LICHTSTAR QUADRUPLE CANOPY, DIAMOND (26" X 18" X 1")

C-8410

C-8410 BB
C-8410 CHROME
C-8410 HB/OB
C-8410 SN

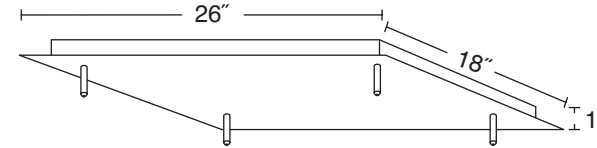

LED PENDANT OPTIONS

LICHTSTAR LED PENDANT
"PUCK"

R-9731*LED BB
R-9731*LED CHROME
R-9731*LED HB/OB
R-9731*LED SN



LICHTSTAR LED PENDANT
"SPHERE"

R-9732*LED BB
R-9732*LED CHROME
R-9732*LED HB/OB
R-9732*LED SN

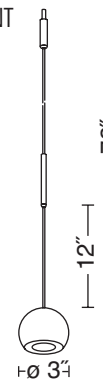

LICHTSTAR LED PENDANT
"CYLINDER"

R-9734*LED BB
R-9734*LED CHROME
R-9734*LED HB/OB
R-9734*LED SN

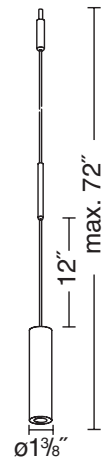

LICHTSTAR LED PENDANT
G-5035

R-9733*LED CHROME
R-9733*LED HB/OB
R-9733*LED PB
R-9733*LED SN

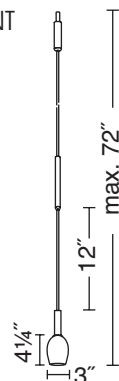

LICHTSTAR LED PENDANT
G-5036

R-9733*LED CHROME
R-9733*LED HB/OB
R-9733*LED PB
R-9733*LED SN

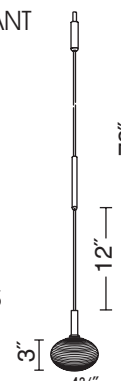

LICHTSTAR LED PENDANT
G-BL10

R-9733*LED CHROME
R-9733*LED HB/OB
R-9733*LED PB
R-9733*LED SN

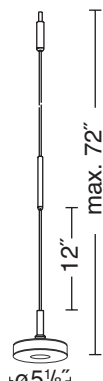

G-5035 SALZBURG GLASS

G-5036 BERCHTESGADEN GLASS

G-BL10 BB
G-BL10 CHROME
G-BL10 HB/OB
G-BL10 SN

HALOGEN REFLECTOR & PENDANT OPTIONS

LICHTSTAR SINGLE SPOT
R-5900

R-5900 BB
R-5900 CHROME
R-5900 HB/OB
R-5900 SN

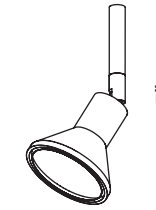

LICHTSTAR HALOGEN PENDANT
G-5770: "NOTE"

G-5770 CHROME
G-5770 HB/OB
G-5770 PB
G-5770 SN
(includes Suspension Kit)

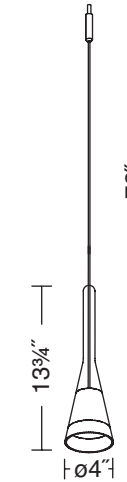

LICHTSTAR HALOGEN PENDANT
FABRIC SHADE

F-2020 IRON RANGE RED
F-2030 IVORY WRAP
(includes S-006 Suspension Kit)

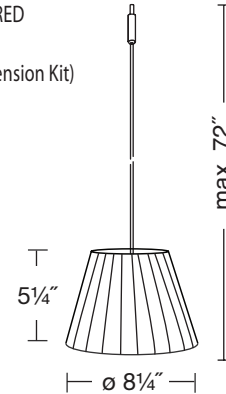

LICHTSTAR HALOGEN PENDANT
G-5701

G-5701
(includes S-006 Suspension Kit)

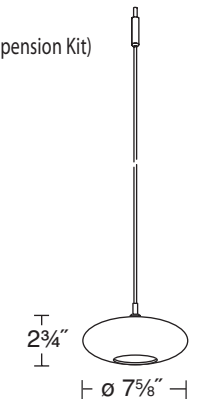

LICHTSTAR HALOGEN PENDANT
G-B20

G-B20 CHROME
G-B20 HB/OB
G-B20 PB
G-B20 SN
(includes S-006 Suspension Kit)

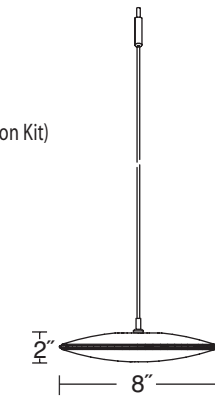

LICHTSTAR HALOGEN PENDANT
G-B60

G-B60 BB
G-B60 CHROME
G-B60 HB/OB
G-B60 PB
G-B60 SN
(includes S-006 Suspension Kit)

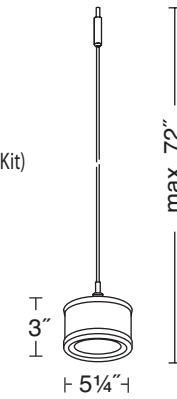

LICHTSTAR HALOGEN PENDANT
G-5035

G-5035 SALZBURG GLASS
(includes S-006 Suspension Kit)



LICHTSTAR HALOGEN PENDANT
G-5036

G-5036 BERCHTESGADEN GLASS
(includes S-006 Suspension Kit)

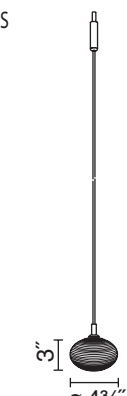

LICHTSTAR HALOGEN PENDANT
G-B10

G-B10 BB
G-B10 CHROME
G-B10 HB/OB
G-B10 SN
(includes S-006 Suspension Kit)

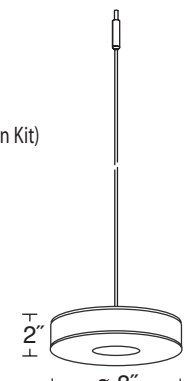

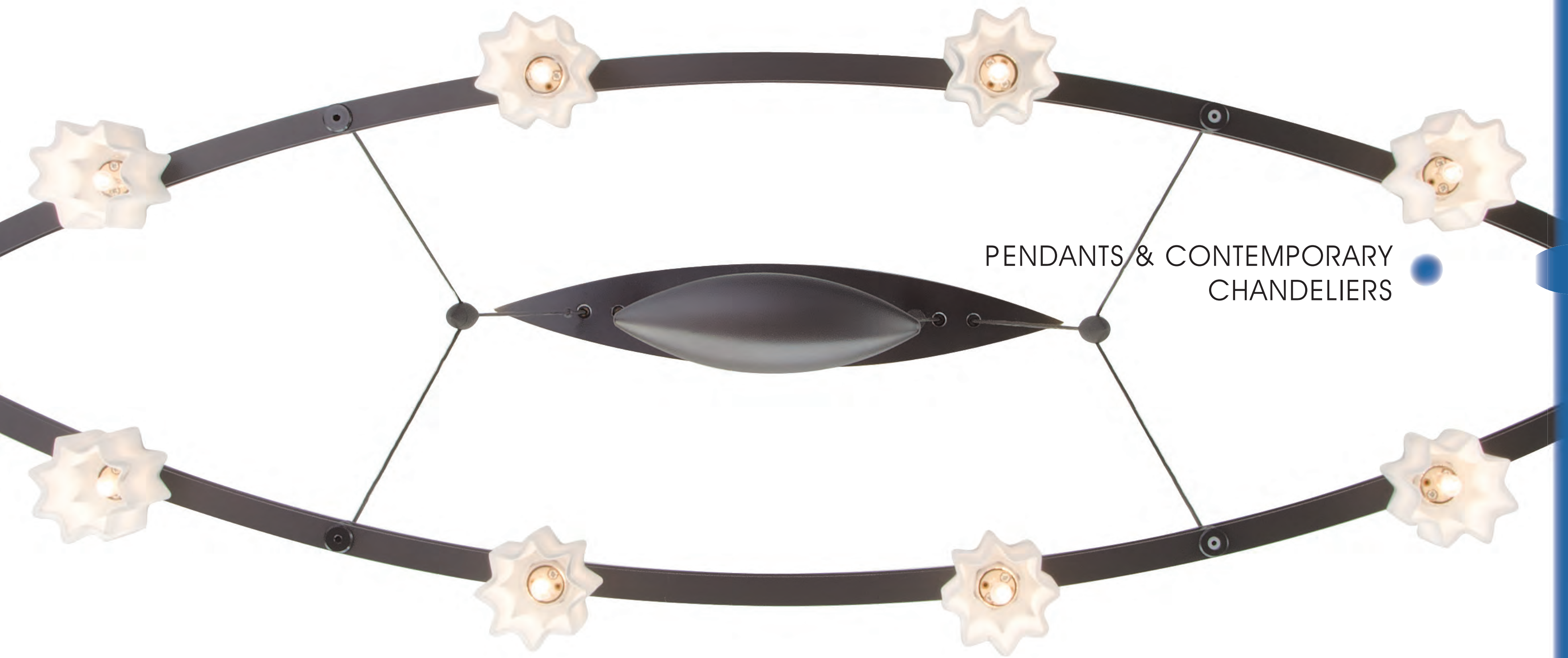

PENDANTS & CONTEMPORARY
CHANDELIERS





9630*LED HBOB

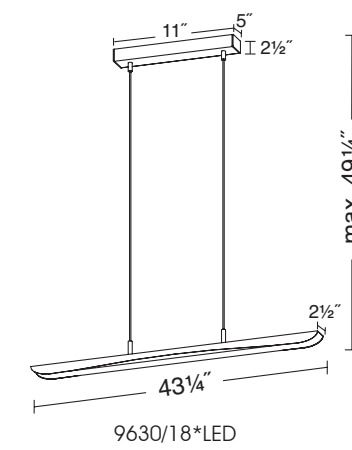

9630/18*LED

9630*LED
SLIGHT

FINISH OPTIONS



DIMENSIONS / BULBS

- Light Engine:** 1x Holtkötter PC Boards LED 13-18 with 18x LEDs
- Optic/Reflector:** Holtkötter Aluminum Reflector with Translucent Acrylic Lens
- Light Output:** 1500 Lumens equivalent to 100 W Halogen
- Light Color:** 2900 Kelvin
- Control/LED Driver/Dimmer:** Holtkötter dimmability with ELV dimmer with full-range dimming of < 1% - 100%
- Maximum Current/Voltage:** 1400mA & 25V
- System Power Consumption:** 3 ... 35 Watts

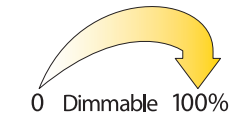

RELATED ITEMS





9618*LED
KONTINUUM



9618*LED HBOB

FINISH OPTIONS

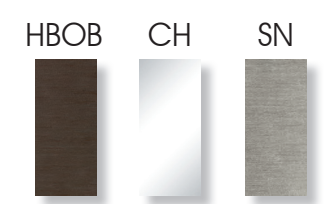

Hang-Straight Kit for 9618 is optional and sold separately. Order Code: 9621/9622-HSK
Custom lengths can be special ordered.

DIMENSIONS / BULBS

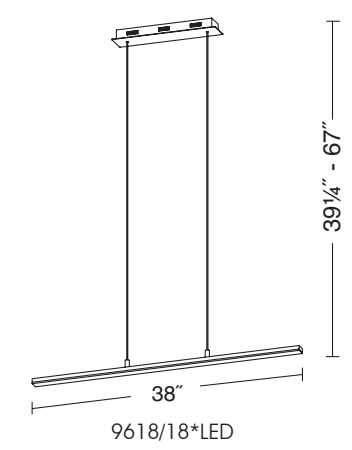

- Light Engine:** 1x Holtkötter PC Boards LED 13-18 with 18x LEDs
- Optic/Reflector:** Holtkötter Aluminum Reflector with Translucent Acrylic Lens
- Light Output:** 1500 Lumens equivalent to 100 W Halogen
- Light Color:** 2900 Kelvin
- Control/LED Driver/Dimmer:** Holtkötter dimmability with ELV dimmer with full-range dimming of < 1% - 100%
- Maximum Current/Voltage:** 1400mA & 25V
- System Power Consumption:** 3...35 Watts

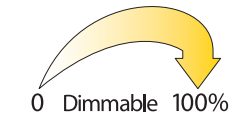

RELATED ITEMS





5556 HBOB G5036



5559 HBOB G5020

5556
5559

FINISH OPTIONS

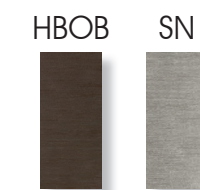

Hang-Straight Kit for 5556 or 5559 is optional and sold separately.
Order Code: 5556-HSK

DIMENSIONS / BULBS

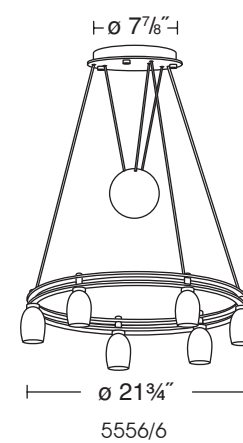

5556: Halostar Starlite® 6x
5559: Halostar Starlite® 9x
12V/20W - GY 6.35 Clear

290 Lumens per bulb
2800 Kelvin

Manufactured by Osram GmbH

9250*020-HSTAR

Fixtures are dimmable. Recommended dimmer:
Lutron Electronic Low Voltage (ELV).

Recommended and optimally manufactured for use
on ceiling heights ranging from 8' - 9'.

When using the Hang-Straight Kit for a vaulted
ceiling, the Hang-Straight Kit will add 6" to the
overall height of the fixture.

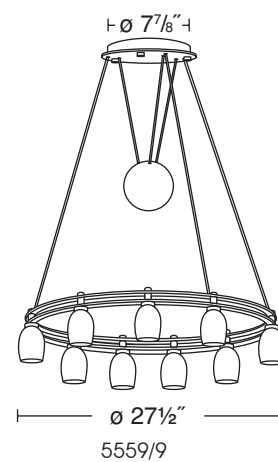
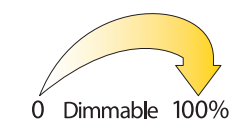

GLASS OPTIONS



RELATED ITEMS

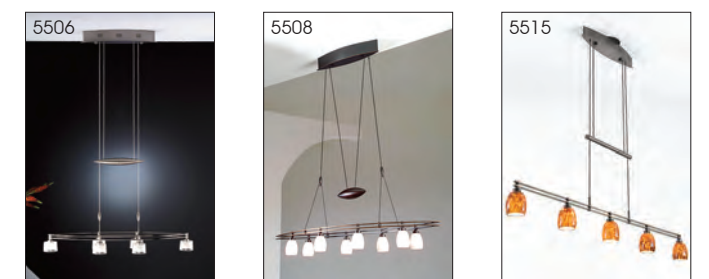



FINISH OPTIONS



Hang-Straight Kit for 5506 is optional and sold separately.
Order Code: 5506-HSK

GLASS OPTIONS



DIMENSIONS / BULBS

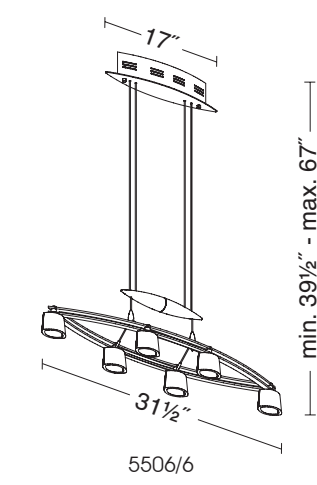

Halostar Starlite® 6x
12V/20W - GY 6.35 Clear
290 Lumens per bulb
2800 Kelvin

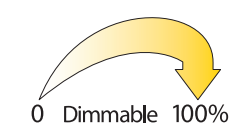

Manufactured by Osram GmbH
9250*020-HSTAR
This fixture is dimmable. Recommended dimmer:
Lutron Electronic Low Voltage (ELV).
Recommended and optimally manufactured for use
on ceiling heights ranging from 8' - 9'.
When using the Hang-Straight Kit for a vaulted
ceiling, the Hang-Straight Kit will add 6" to the
overall height of the fixture.



5508 SN G5014

FINISH OPTIONS

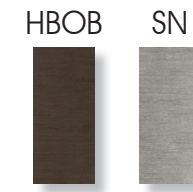

Hang-Straight Kit for 5508 is optional and sold separately.
Order Code: 5508/5907-HSK

GLASS OPTIONS



DIMENSIONS / BULBS

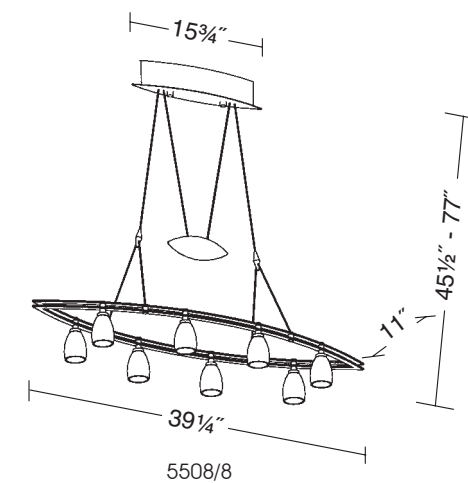

Halostar Starlite® 8x
12V/20W - GY 6.35 Clear

290 Lumens per bulb
2800 Kelvin

Manufactured by Osram GmbH
9250*020-HSTAR

This fixture is dimmable. Recommended dimmer:
Lutron Electronic Low Voltage (ELV).

Recommended and optimally manufactured for use
on ceiling heights ranging from 8' - 9'.

When using the Hang-Straight Kit for a vaulted
ceiling, the Hang-Straight Kit will add 6" to the
overall height of the fixture.

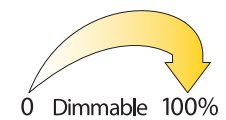



0 Dimmable 100%

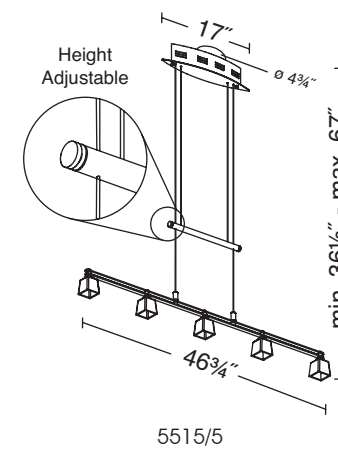

5515 HBOB G5020

DIMENSIONS / BULBS



 **Halostar Starlite®** 5x
12V/20W - GY 6.35 Clear

290 Lumens per bulb
2800 Kelvin

Manufactured by Osram GmbH

9250*020-HSTAR

Fixtures are dimmable. Recommended dimmer:
Lutron Electronic Low Voltage (ELV).

Recommended and optimally manufactured for use
on ceiling heights ranging from 8' - 9'.

When using the Hang-Straight Kit for a vaulted
ceiling, the Hang-Straight Kit will add 6" to the
overall height of the fixture.

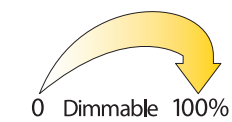

FINISH OPTIONS

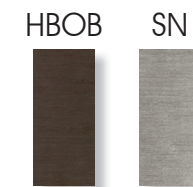

Hang-Straight Kit for 5515 or 5517 is optional and sold separately.
Order Code: 5515-HSK or 5517/5519-HSK

GLASS OPTIONS





FINISH OPTIONS



Hang-Straight Kit for 5515 or 5517 is optional and sold separately.
Order Code: 5515-HSK or 5517/5519-HSK

DIMENSIONS / BULBS

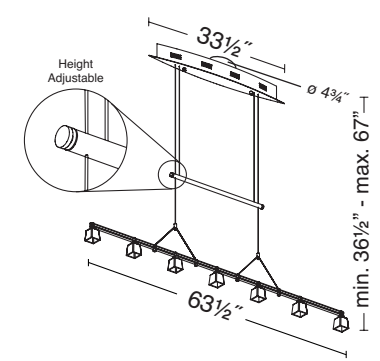

5517/7



Halostar Starlite® 7x
12V/20W - GY 6.35 Clear
290 Lumens per bulb
2800 Kelvin

Manufactured by Osram GmbH

9250*020-HSTAR

Fixtures are dimmable. Recommended dimmer:
Lutron Electronic Low Voltage (ELV).

Recommended and optimally manufactured for use
on ceiling heights ranging from 8' - 9'.

When using the Hang-Straight Kit for a vaulted
ceiling, the Hang-Straight Kit will add 6" to the
overall height of the fixture.

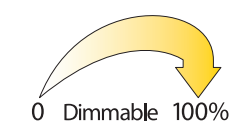

0 Dimmable 100%

GLASS OPTIONS



G-B50
BB, CH, HB, PB, SN



5701 HBOB GB10

5701

FINISH OPTIONS

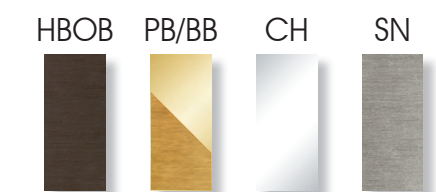

Hang-Straight Kit for 5701 is optional, sold separately and must be factory installed. Order Code: 5701-HSK

DIMENSIONS / BULBS

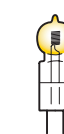
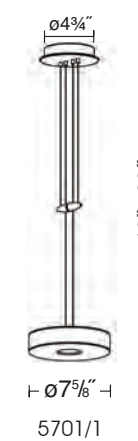

Halostar ECO 1x
12V/50W - GY 6.35 IRC

1180 Lumens
3000 Kelvin

Manufactured by Osram GmbH

9250*050-HSTAR

This fixture is dimmable. Recommended dimmer: Lutron Electronic Low Voltage (ELV).

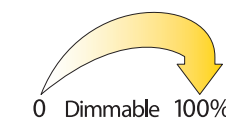

0 Dimmable 100%

GLASS OPTIONS

G-5701



G-B50
BB, CH, HB, PB, SN



G-B20
CH, HB, PB, SN



G-B60
BB, CH, HB, PB, SN



G-B10
BB, CH, HB, SN



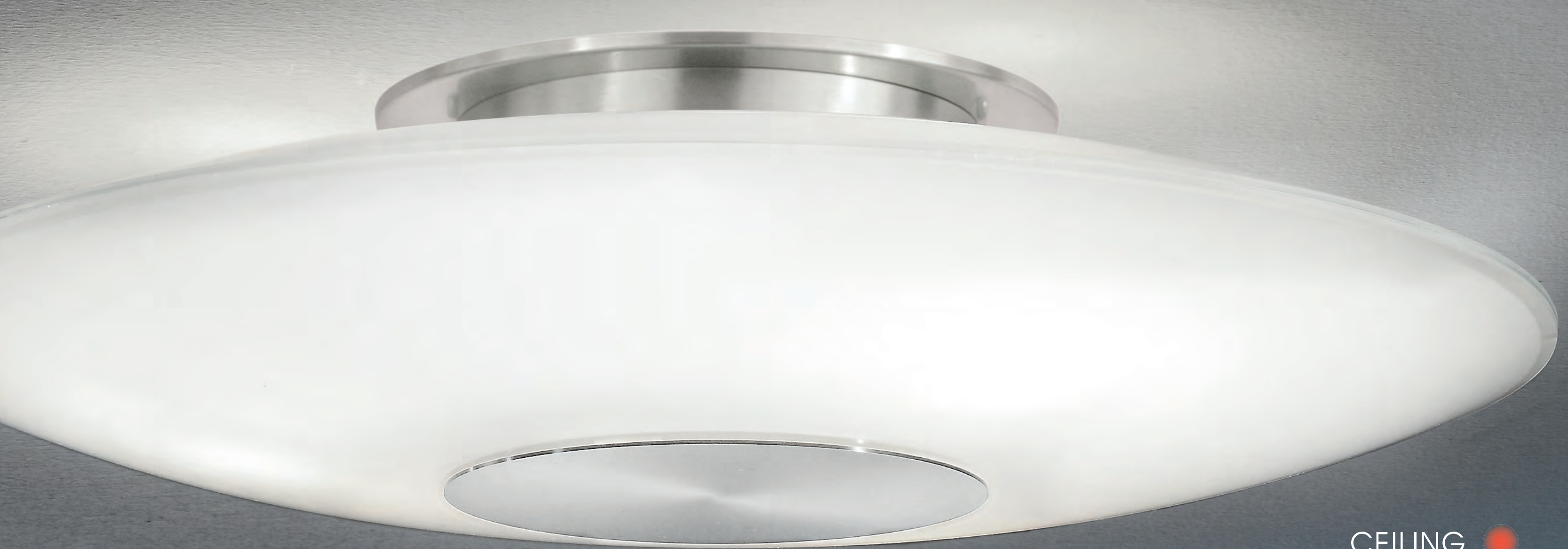

CEILING





5403 S
5403 L

5403 HBOB S

FINISH OPTIONS



Please indicate a shade size of 17" or 20" diameter when ordering

DIMENSIONS / BULBS

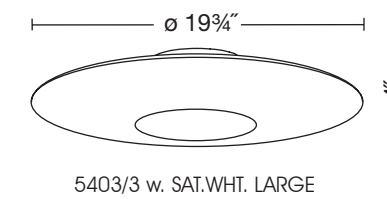
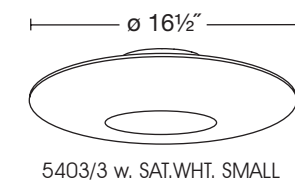

Osram Halopin® 3x
120V/60W - G9 Frosted
790 Lumens per bulb (Σ 2370)
2900 Kelvin

Manufactured by Osram GmbH



9250*060-HPNFR
5403 L and 5403 S are dimmable using a conventional wall dimmer.

RELATED ITEMS



5403 BB L



5401 BB

5401



5401 HBOB



5401 SN

FINISH OPTIONS



DIMENSIONS / BULBS

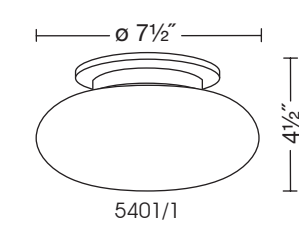

Osram Halopin® 1x
120V/60W - G9 Frosted

790 Lumens
2900 Kelvin

Manufactured by Osram GmbH

9250*060-HPNFR

0 Dimmable 100%

Dimmable using a conventional wall dimmer.

RELATED ITEMS

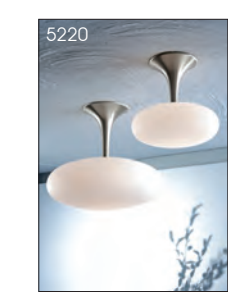
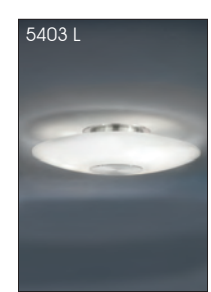



5402 SN S



5402 HBOB L

5402 S
5402 L

FINISH OPTIONS



Please indicate a shade size of 13½" or 16½" diameter when ordering

DIMENSIONS / BULBS

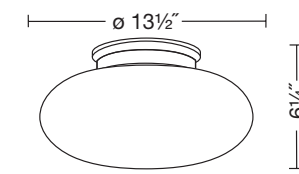

5402/1 with 5402 . SATIN WHITE

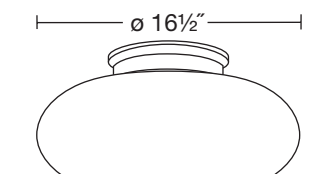

5402/1 with 5402 . SATIN WHITE-LG



Osram Halopin® 1x
120V/75W - G9 Frosted

1300 Lumens
2800 Kelvin

Manufactured by Bulbrite Industries

9250*075-HPNFR

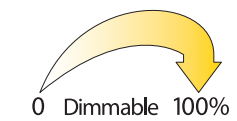

0 Dimmable 100% Dimmable using a conventional wall dimmer.

RELATED ITEMS





3505 SN DEK

3502
3503
3505

DEKOR FINISH OPTIONS

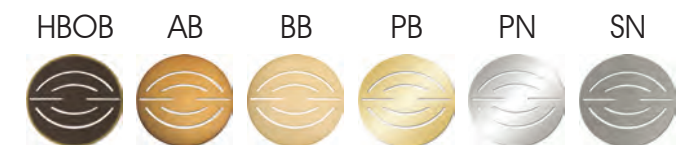

SOLID FINISH OPTIONS

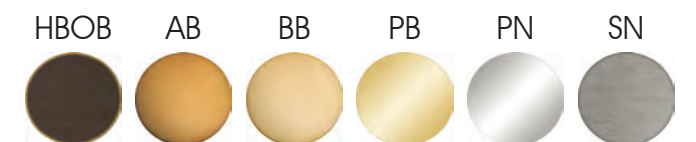

When ordering, please indicate either a Dekor or Solid finish option.

DIMENSIONS / BULBS

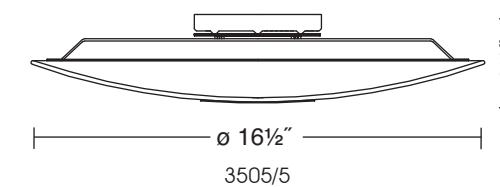
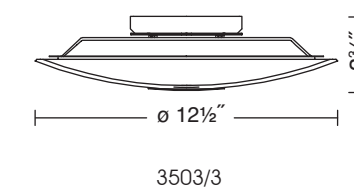
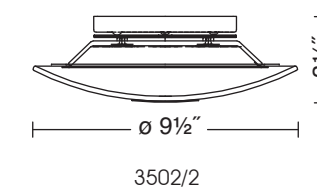

3502: Osram Halopin® 2x
3503: Osram Halopin® 3x
3505: Osram Halopin® 5x
 120V/60W - G9 Frosted

790 Lumens per bulb
 2900 Kelvin

Manufactured by Osram GmbH

9250*060-HPNFR

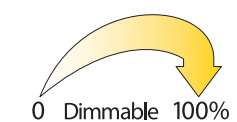

Fixtures 3502, 3503 and 3505 are dimmable using a conventional wall dimmer.



3603DEK HBOB PBR



3605DEK SN HSV

3603
3605

GLASS OPTIONS

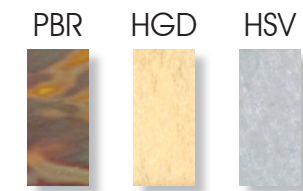

When ordering, please indicate a glass choice and either a Dekor or Solid finish option.

DEKOR FINISH OPTIONS

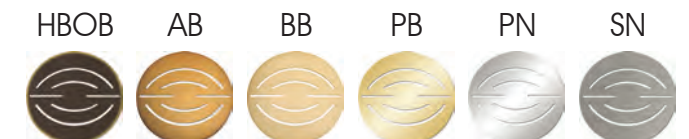

SOLID FINISH OPTIONS

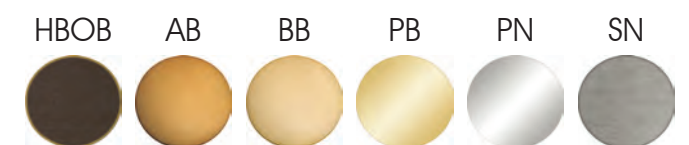

DIMENSIONS / BULBS

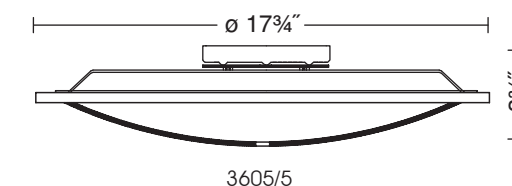
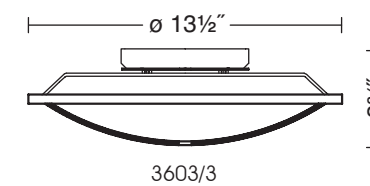

3603: Osram Halopin® 3x
3605: Osram Halopin® 5x
 120V/60W - G9 Frosted

790 Lumens per bulb
 2900 Kelvin

Manufactured by Osram GmbH

9250*060-HPNFR

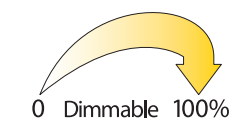

Fixtures 3603 and 3605 are dimmable using a conventional wall dimmer.



5220
5221

FINISH OPTIONS

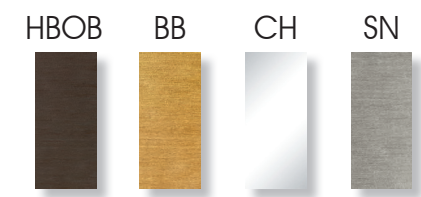

DIMENSIONS / BULBS

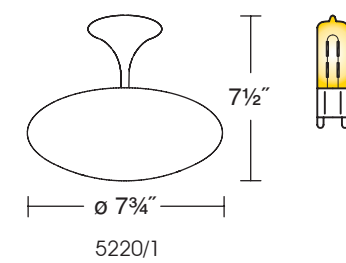

5220: Osram Halopin® 1x
120V/60W - G9 Frosted

790 Lumens
2900 Kelvin

Manufactured by Osram GmbH

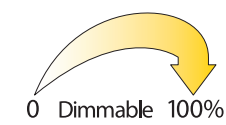

9250*060-HPNFR
Dimmable using a conventional wall dimmer.

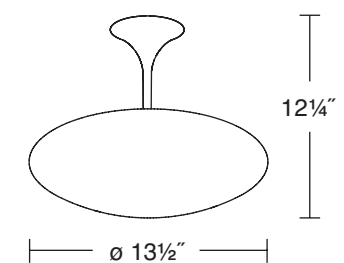

5221: Halolux® Ceram 1x
120V/100W - B15d Clear

1500 Lumens
2900 Kelvin

Manufactured by Osram GmbH

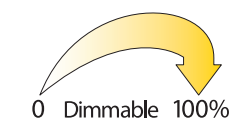

9250*100-DC/CL
Dimmable using a conventional wall dimmer.

RELATED ITEMS





5231 CH SW LARGE



5231 CH SW SMALL

FINISH OPTIONS

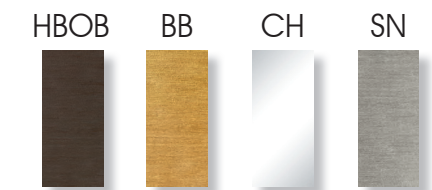

Please indicate a shade size of 17" or 20" diameter when ordering

DIMENSIONS / BULBS

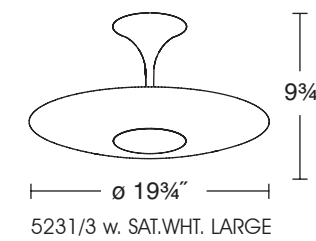
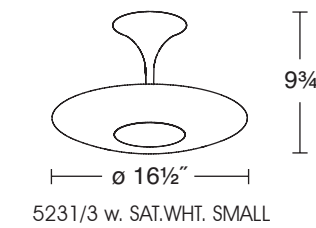

Halogen G9 3x
120V/75W - G9 Frosted

1300 Lumens per bulb
2800 Kelvin

Manufactured by Bulbrite Industries

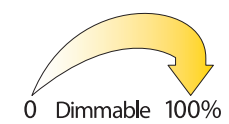

9250*075-HPNFR

0 Dimmable 100% Dimmable using a conventional wall dimmer.

RELATED ITEMS

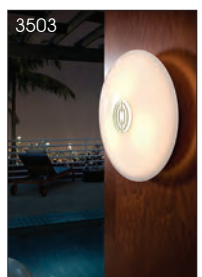



BATH & DECORATIVE SCONCES



FILIA S 8531
 FILIA L 8532



8531 HBOB



8532 STS

FINISH OPTIONS



DIMENSIONS / BULBS

8" 4" 100% Dimmer 0

8531: Halogen G9 1x
 120V/75W - G9 Frosted
 1300 Lumens / 2800 Kelvin

Manufactured by
 Bulbrite Industries

9250*075-HPNFR

Dimmable using a conventional wall dimmer.

8" 6 3/4" 100% Dimmer 0

8532: Osram Halopin® 2x
 120V/60W - G9 Frosted
 790 Lumens per bulb (Σ 1580)
 2900 Kelvin

Manufactured by Osram GmbH

9250*060-HPNFR

Dimmable using a conventional wall dimmer.



8501 STS



8501 HBOB

8501
VOILÀ

FINISH OPTIONS



DIMENSIONS / BULBS

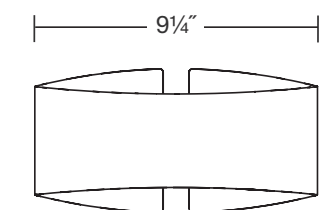

Extends 4 1/2"

8501/1



Halogen G9 1x
120V/75W - G9 Frosted

1300 Lumens
2800 Kelvin

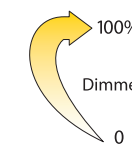

Manufactured by
Bulbrite Industries

9250*075-HPNFR

Dimmable using a conventional wall dimmer.

RELATED ITEMS



8532



8502



8520



8502 BK

8502
8503
VOILÀ GLASS

FINISH OPTIONS

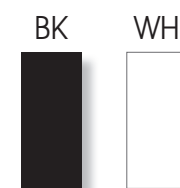

DIMENSIONS / BULBS

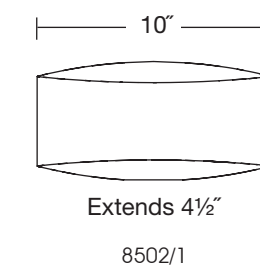
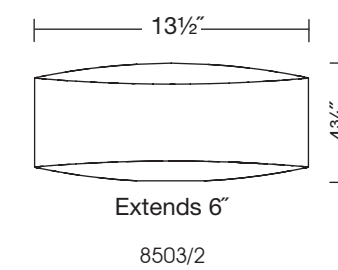

8502: Osram Halopin® 1x
8503: Osram Halopin® 2x
120V/60W - G9 Frosted

790 Lumens per bulb
2900 Kelvin

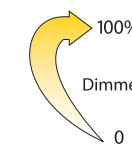

Manufactured by Osram GmbH

9250*060-HPNFR

Dimmable using a conventional wall dimmer.

RELATED ITEMS





8520
QUERGEDACHT

FINISH OPTIONS

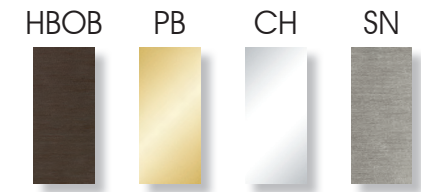

DIMENSIONS / BULBS



1x
Halogen G9
120V/75W - G9 Frosted
1300 Lumens / 2800 Kelvin
100% Dimmer
Manufactured by Bulbrite Industries
0 9250*075-HPNFR
Dimmable using a conventional wall dimmer.

RELATED ITEMS





FINISH OPTIONS

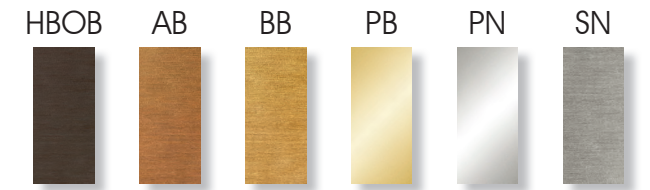

GLASS OPTIONS

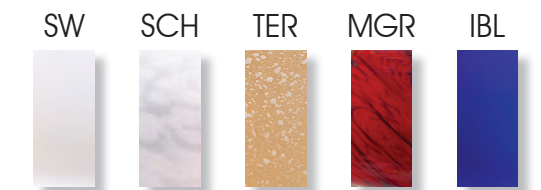

DIMENSIONS / BULBS

5 1/4"

3 1/4"

4 1/2"

2977/1

Double-Ended Halogen 1x
120V/100W - T3Q

1300 Lumens
2900 Kelvin

Manufactured by
Bulbrite Industries

100%
Dimmer
0

9250*100-T3-1/8

Dimmable using a conventional wall dimmer.

RELATED ITEMS





2969 PN IBL

FINISH OPTIONS

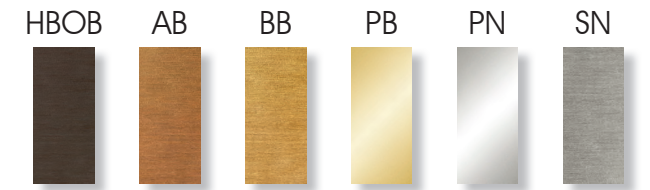

GLASS OPTIONS

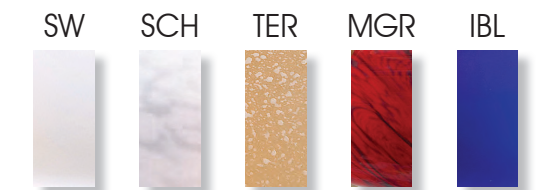

DIMENSIONS / BULBS

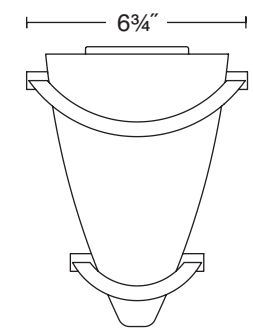

Extends 4 1/2"

2969/1



Double-Ended Halogen 1x
120V/100W - T3Q

1300 Lumens
2900 Kelvin

Manufactured by
Bulbrite Industries

9250*100-T3

Dimmable using a conventional wall dimmer.

RELATED ITEMS





5583 Halogen ECO/IRC
5584 Halogen ECO/IRC

FINISH OPTIONS

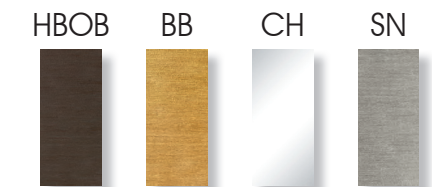

GLASS OPTIONS



Please note: It is recommended that glass G-5030 and glass G-5031 be installed only facing upwards.

DIMENSIONS / BULBS

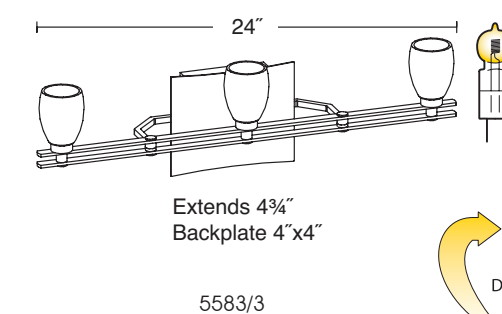
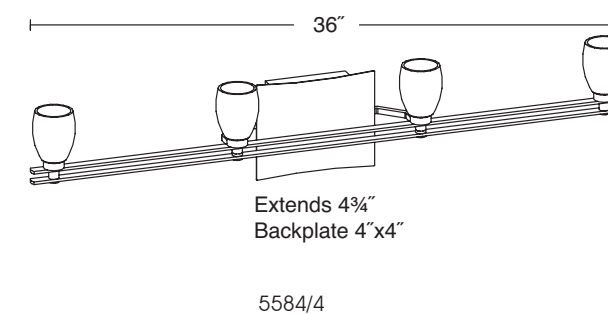

5583: Halostar ECO 3x
5584: Halostar ECO 4x
12V/35W - GY 6.35 IRC

860 Lumens per bulb
2900 Kelvin

Manufactured by Osram GmbH
9250*035-HSTAR

Fixtures 5583 & 5584 are dimmable. Recommended dimmer: Lutron Electronic Low Voltage (ELV).

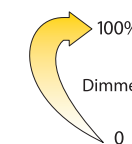



SWING-ARM WALL SCONCES





9642*LED - LEFT
9643*LED - RIGHT
CLEO

9642*LED / 9643*LED Reflector Detail

FINISH OPTIONS

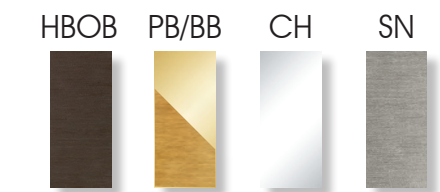

DIMENSIONS

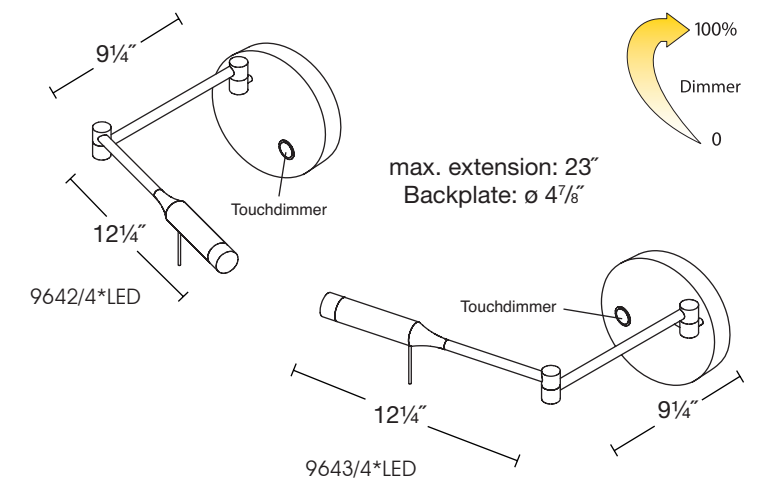

DIMMER DETAILS

The Dimm-System Punkt 1 (*P1) has the following features:

Point Dimming - the lamp may be turned on with a single click of the P1 dimmer.

Soft On - the lamp will come on low and continue to brighten to full brightness. This allows the eye to adjust to a gradual increase in light.

Soft / Delayed Off - turn the lamp off with a single click of the P1 dimmer. The lamp will dim to 60% brightness of the original setting, remaining briefly at that level to allow you to exit the room, then the lamp gradually turns itself off. This "soft" off provides a few moments of light after turning the lamp off, rather than immediate darkness as is the case with other switches.

Dimming Cycle - to adjust the lamp to the perfect light level for any situation, press and hold the P1 dimmer. The dimmer will cycle through all dimming levels. When the lamp achieves the light level of your choice, release the P1 dimmer.

LED SPECIFICATIONS

- Light Engine:** Holtkötter PC Board LED 13-4 with 4x Citizen CL400 LED
- Optic / Reflector:** Holtkötter Aluminum Reflector 28 x 58mm with 60° x 5mm Optics
- Light Output:** 550 Lumens equivalent to 50W Halogen
- Light Color:** 3000 Kelvin
- Control/LED Driver/Dimmer:** Holtkötter Dimm-System LED TOUCH with full-range dimming of < 1% - 100%
- Maximum Current/Voltage:** 500mA & 16V
- System Power Consumption:** 2...6 Watts



FINISH OPTIONS

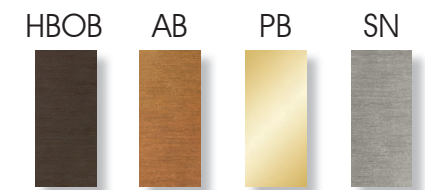

Features a special lens that can adjust the spread and intensity of the beam of light.

DIMENSIONS / BULBS

adjustable arm length: 22½"

6265/1

Halostar Starlite®
12V/20W - G4 Clear 1x

300 Lumens
2800 Kelvin

100%
Dimmer
0

Manufactured by
Osram GmbH

9250*020-HSTAR-G4

Equipped with a full-range, turn-knob dimmer.

OPTIONAL ACCESSORIES



Pin-Up Kit for 6265
Order code: 8191 PIN UP KIT
Please refer to finish options above when ordering. Sold separately.

8191 with 8191 PUK HBOB



ECO/IRC Detail



LED Detail

8193 Halogen ECO/IRC
8193*LED
BERNIE SERIES

FINISH OPTIONS

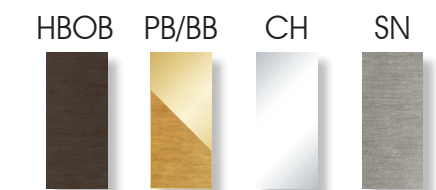

DIMENSIONS / BULBS

max. extension: 28 1/4"

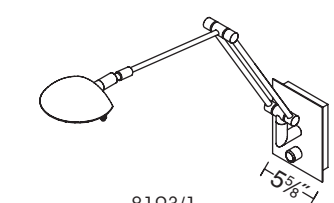

8193/1
8193/8*LED



8193 ECO/IRC:
Halostar ECO
12V/60W - GY 6.35 IRC

1x

1650 Lumens
3000 Kelvin

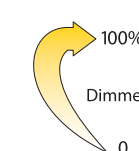

Manufactured by Osram GmbH

9250*060-HSTAR

Equipped with a full-range, turn-knob dimmer.

OPTIONAL ACCESSORIES



8191 with 8191 PUK HBOB

Pin-Up Kit for 8193 ECO/IRC
Pin-Up Kit for 8195 ECO/IRC
Pin-Up Kit for 8193 LED
Pin-Up Kit for 8195 LED
Order code: 8191 PIN UP KIT

Please refer to finish options above when ordering.
Sold separately.

LED SPECIFICATIONS

Light Engine:	Holtkötter PC Board LED 11-8 with 8x CREE XP-G LEDs
Optic / Reflector:	Holtkötter Aluminum Reflector ø 134x100 with 60° x 5mm Optics
Light Output:	1120 Lumens, equivalent to 80 W Halogen
Light Color:	2900 Kelvin
Control/LED Driver/Dimmer:	Holtkötter Dimm-System LED with full-range dimming of < 1% - 100%
Maximum Current/Voltage:	500mA & 16V
System Power Consumption:	2...8 Watt



8195 Halogen ECO/IRC
8195*LED
BERNIE SERIES



ECO/IRC Detail



LED Detail

FINISH OPTIONS

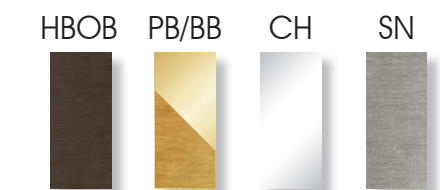

DIMENSIONS / BULBS

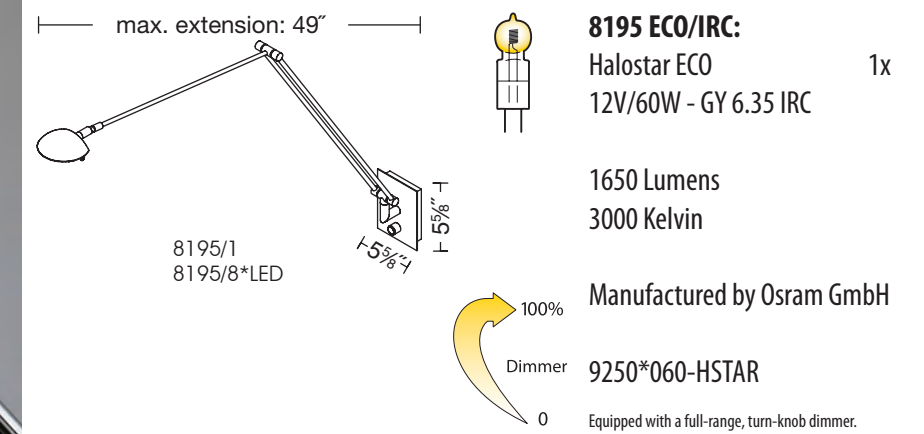

OPTIONAL ACCESSORIES



8191 with 8191 PUK HBOB

Pin-Up Kit for 8193 ECO/IRC
Pin-Up Kit for 8195 ECO/IRC
Pin-Up Kit for 8193 LED
Pin-Up Kit for 8195 LED
Order code: 8191 PIN UP KIT

Please refer to finish options above when ordering.
Sold separately.

LED SPECIFICATIONS

Light Engine: Holtkötter PC Board LED 11-8 with 8x CREE XP-G LEDs
Optic / Reflector: Holtkötter Aluminum Reflector ø 134x100 with 60° x 5mm Optics
Light Output: 1120 Lumens, equivalent to 80 W Halogen
Light Color: 2900 Kelvin
Control/LED Driver/Dimmer: Holtkötter Dimm-System LED with full-range dimming of < 1% - 100%
Maximum Current/Voltage: 1000mA & 14V
System Power Consumption: 2...14 Watt



8192 CH

8191 Halogen ECO/IRC
8192 Halogen ECO/IRC
BERNIE SERIES

FINISH OPTIONS

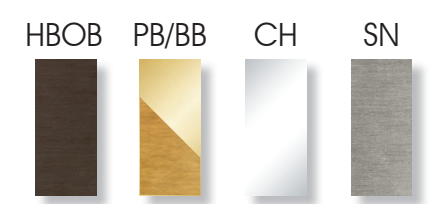

DIMENSIONS / BULBS

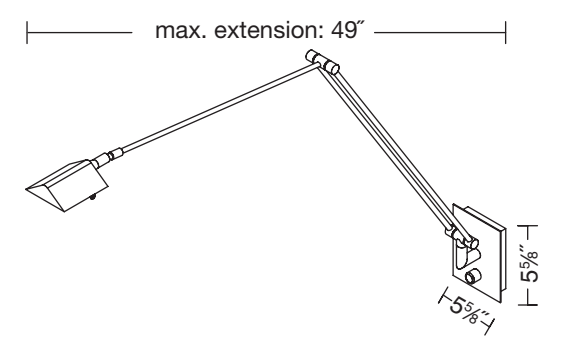

8192/1

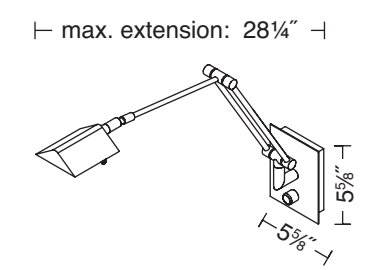

8191/1

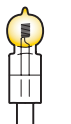
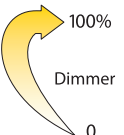
Halostar ECO 1x
 12V/50W - GY 6.35 IRC
 1180 Lumens
 3000 Kelvin
 Manufactured by Osram GmbH

 100%
 Dimmer
 0
9250*050-HSTAR
 Equipped with a full-range, turn-knob dimmer.

OPTIONAL ACCESSORIES



8191 with 8191 PUK HBOB

Pin-Up Kit for 8191
Pin-Up Kit for 8192
Order code: 8191 PIN UP KIT

Please refer to finish options above when ordering. Sold separately.



FINISH OPTIONS

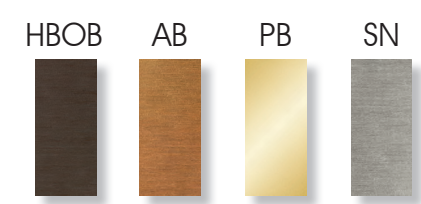

DIMENSIONS / BULBS

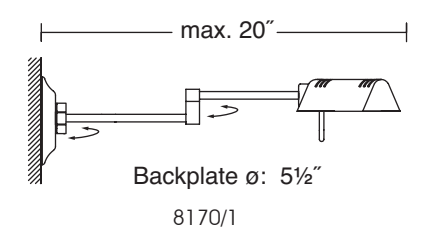

1x
Halolux® Ceram
 120V/75W - B15d Clear
 1100 Lumens
 2900 Kelvin
 Manufactured by Osram GmbH
 9250*075-DC/CL
 Equipped with a full-range, turn-knob dimmer.

OPTIONAL ACCESSORIES

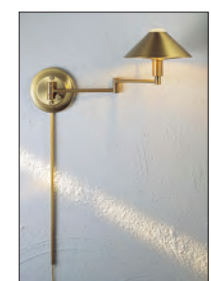

Pin-Up Kit for 8170
 Order code: 9426 PIN UP KIT
 Please refer to finish options above when ordering. Sold separately.

9416 with 9426 PUK AB



522 HBOB

522
523

FINISH OPTIONS

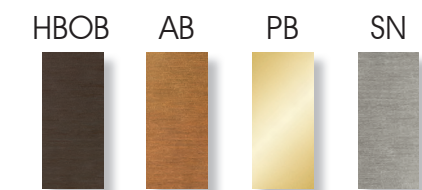

DIMENSIONS / BULBS

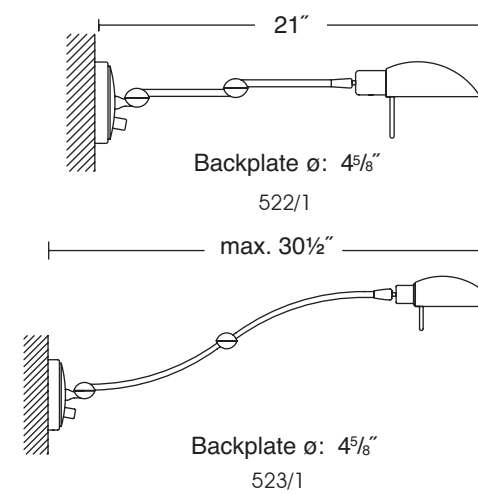

522 & 523:
Halolux® Ceram 1x
120V/100W - B15d Clear

1500 Lumens
2900 Kelvin

Manufactured by Osram GmbH

9250*100-DC/CL

Equipped with a full-range, turn-knob dimmer.

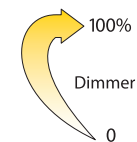

OPTIONAL ACCESSORIES



Pin-Up Kit for 522
Pin-Up Kit for 523
Order Code: 8160 PIN UP KIT

Please refer to finish options above when ordering. Sold separately.

522 with 8160 PUK AB



9416 HBOB



9426 SN AWH

9416

9426

LIGHTING FOR THE AGING EYE

FINISH OPTIONS

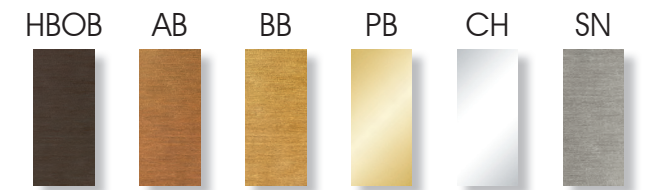

GLASS OPTIONS

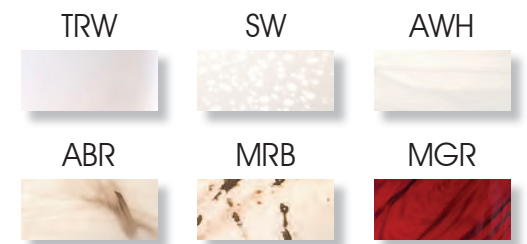

When ordering, please indicate a glass choice for item No. 9426.

DIMENSIONS / BULBS

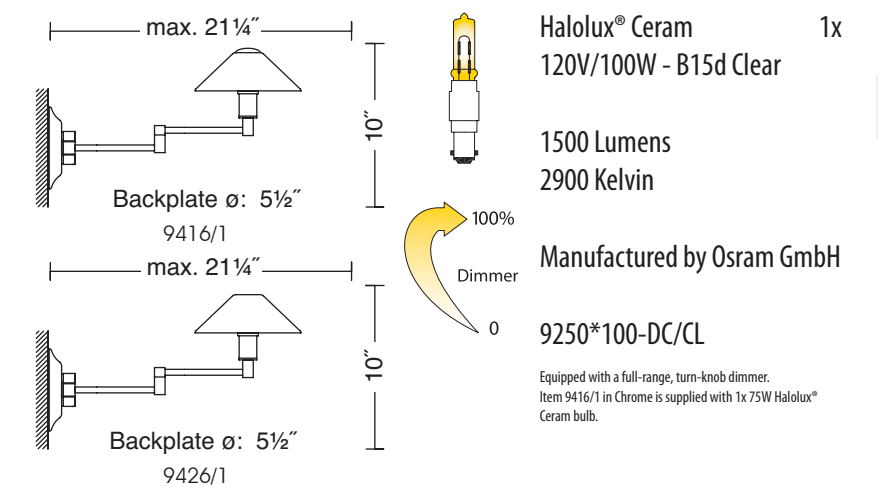

OPTIONAL ACCESSORIES

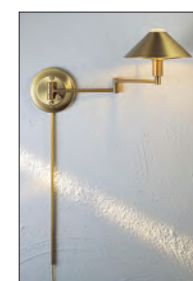

Pin-Up Kit for 9416
Pin-Up Kit for 9426
Order code: 9426 PIN UP KIT

Please refer to finish options above when ordering. Sold separately.

9416 with 9426 PUK AB



FINISH OPTIONS

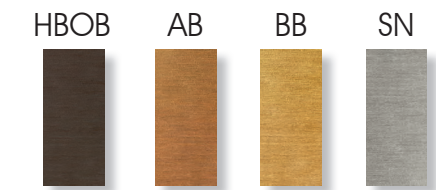

SHADE OPTIONS



DIMENSIONS / BULBS

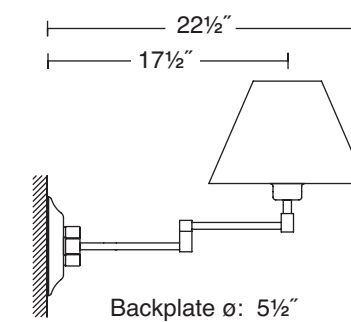

Backplate ø: 5 1/2"

8164/1

120V/max. 75W 1x
Medium Base, not included.

Shade Dimensions:
Shade Top ø 4 3/4"
Shade Bottom ø 10 1/4"
Shade Height 7"

100%
Dimmer Equipped with a full-range, turn-knob dimmer.
0

OPTIONAL ACCESSORIES

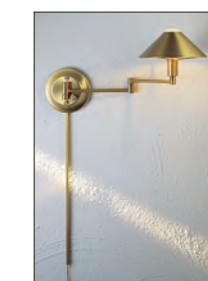

Pin-Up Kit for 8164
Order code: 9426 PIN UP KIT

Please refer to finish options above when ordering. Sold separately.

9416 with 9426 PUK AB

CHAIRSIDE READING 04



TABLE, DESK & TASK LAMPS 60

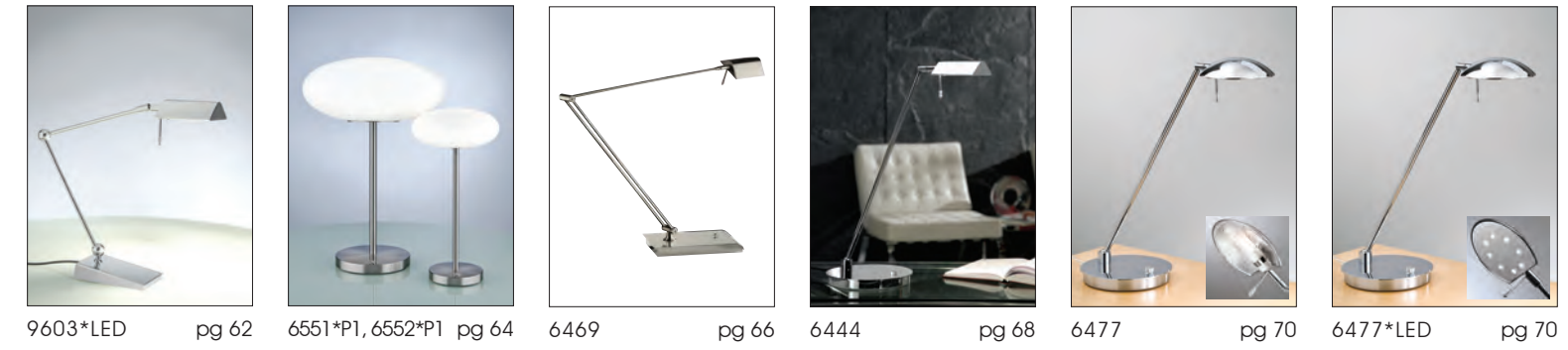

VOLKSLAMPE 88





C-8110 C-8120 C-8310 C-8410



C-9750 R-5900 G-5770 F-2020 F-2030



G-5035 G-5036 G-5701 G-B10 G-B20 G-B60



R-9731*LED R-9732*LED R-9734*LED R-9733*LED G-5035 R-9733*LED G-5036 R-9733*LED G-BL10

*Lichtstar components can be found in various locations from page 98-131.



C-9750 pg 100 R-9733*LED G-BL10 C-9750 S-006 pg 102 F-2020 C-8110 pg 104 R-9732*LED R-9733*LED pg 106 G-BL10 C-8110 S-006 pg 108 F-2030 C-8120 S-006 pg 110 G-B60



C-8110 pg 112 R-5900 C-8110 pg 114 G-5770 C-8410 pg 116 G-5770 C-8310 pg 116 G-5770 C-8310 pg 118 R-5900 C-8410 pg 118 R-5900



C-8310 pg 120 R-9734*LED C-8310 pg 122 G-5701 C-8410 pg 124 R-9732*LED C-8410 G-B60 pg 126 C-8410 pg 128 R-9733*LED G-5036



9630*LED pg 134 9618*LED pg 136 5556 pg 138 5559 pg 138 5506 pg 140



5508 pg 142 5515 pg 144 5517 pg 146 5701 pg 148

CEILING 150



BATH & DECORATIVE SCONCES 166

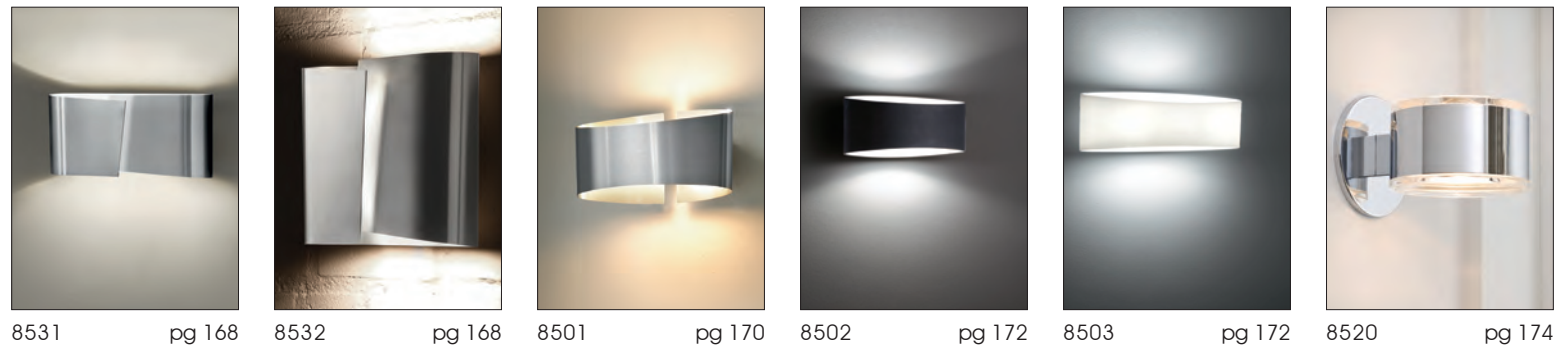

SWING-ARM WALL SCONCES 182

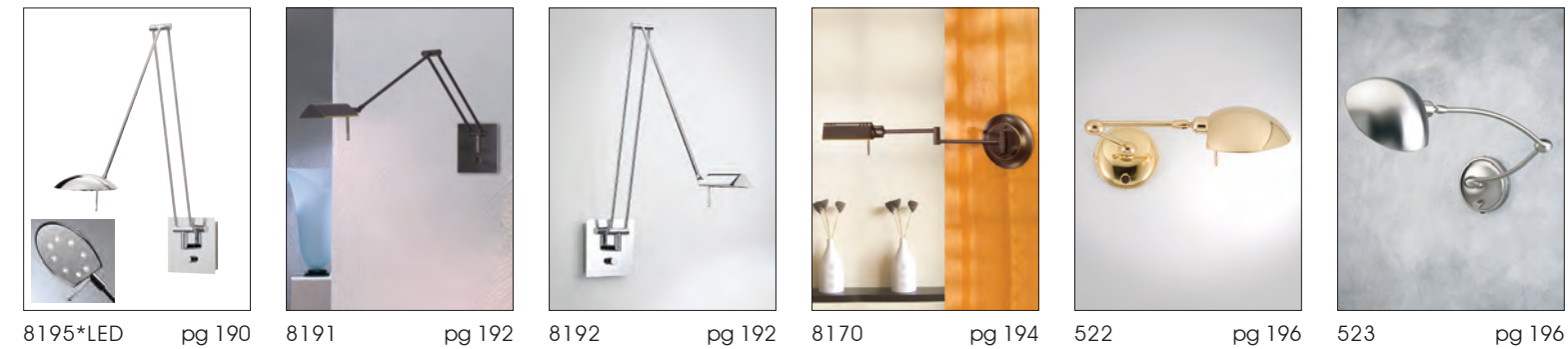

NUMERICAL INDEX

Item No.	Page	Item No.	Page	Item No.	Page
2501	54/55	6317 SLD	18/19	9426	198/199
2505	28/29	6317*LED SLD	20/21	9434	14/15
2508	22/23	6354	44/45	9602*LED	6/7
2508*P1	24/25	6420*P1	40/41	9603*LED	62/63
2508*LED P1	26/27	6424*P1	36/37	9618*LED	136/137
2517*P1	58/59	6424*LED P1	36/37	9630*LED	134/135
2541	48/49	6440	42/43	9642*LED	184/185
2545	46/47	6444	68/69	9643*LED	184/185
2560*LED P1	56/57	6450*P1	30/31	9680*P1 LED	34/35
2573	52/53	6451	32/33		
2625*LED P1	50/51	6469	66/67		
2969	178/179	6470	38/39		
2977	176/177	6470*LED	38/39		
3502	158/159	6477	70/71		
3503	158/159	6477*LED	70/71		
3505	158/159	6504	78/79		
3603	160/161	6505	12/13		
3605	160/161	6506	76/77		
522	196/197	6514	78/79		
5220	162/163	6515	12/13		
5221	162/163	6541*P1	8/9		
523	196/197	6542*P1	8/9		
5231 LG	164/165	6551*P1	64/65		
5231 SM	164/165	6552*P1	64/65		
5401	154/155	6560	10/11		
5402	156/157	6561	10/11		
5402 LG	156/157	6562	10/11		
5403 LG	152/153	8164	200/201		
5403 SM	152/153	8170	194/195		
5506	140/141	8191 . PIN UP KIT	192/193		
5508	142/143	8191	192/193		
5515	144/145	8192	192/193		
5517	146/147	8193	188/189		
5556	138/139	8193*LED	188/189		
5559	138/139	8195	190/191		
5583	180/181	8195*LED	190/191		
5584	180/181	8346	74/75		
5701	148/149	8501	170/171		
6031	86/87	8502	172/173		
6032	86/87	8503	172/173		
6238	72/73	8520	174/175		
6243	82/83	8531	168/169		
6244	80/81	8532	168/169		
6263	84/85	9416	198/199		
6265	186/187	9424	14/15		
6317	16/17	9426 . PIN UP KIT	198/199		

■ VOLKSLAMPE

VL100	90/91
VL200	92/93
VL300	94/95
VL500	96/97

■ LICHTSTAR SYSTEM

INFORMATION 130/131

C-8110	104-115
C-8120	104-115
C-8310	116-123
C-8410	116-119/124-129
C-9750	100-103

F-2020	102/103/108/109
	122/123/126/127
F-2030	102/103/108/109
	122/123/126/127

G-5035	130/131
G-5036	130/131
G-5701	130/131
G-5770	114-117/130/131
G-BL10	130/131
G-B10	130/131
G-B20	130/131
G-B60	130/131

R-5900	112/113/118/119
R-9731*LED	130/131
R-9732*LED	130/131
R-9733*LED	130/131
R-9734*LED	130/131

Holtkötter Finish Options

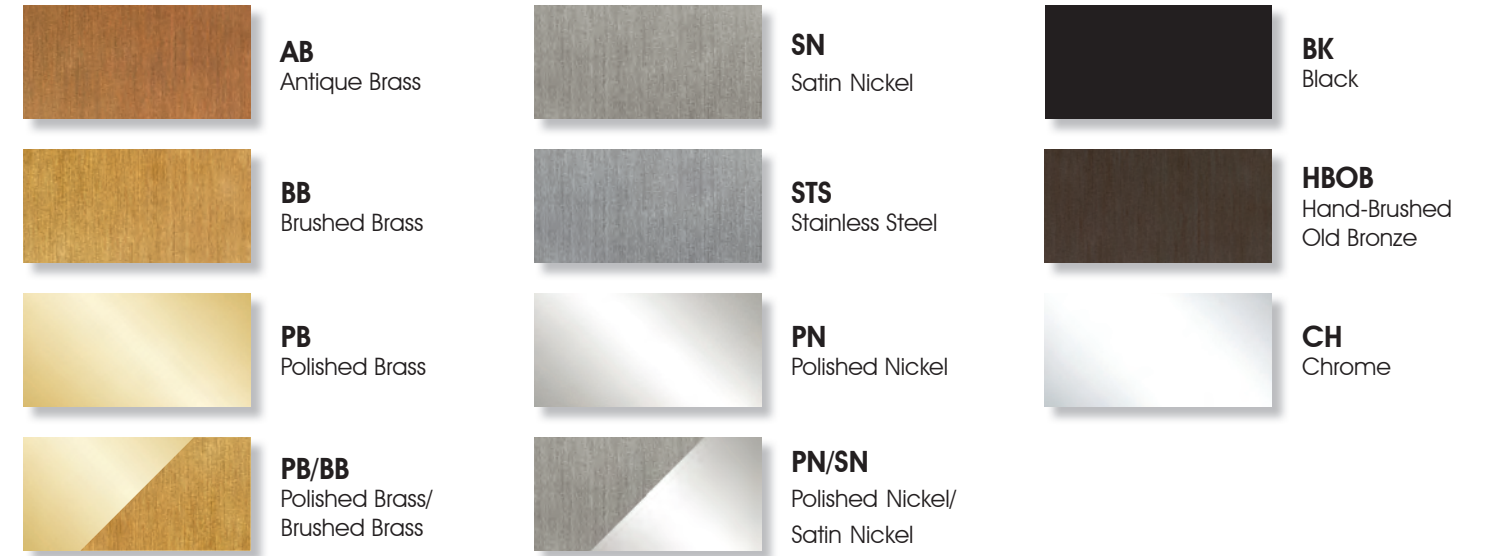

Holtkötter Glass Options



Holtkötter Shade Options

